

---

## 2-Axis Laser Beam Deflection Units

SUPERSCAN III



This manual has been compiled by RAYLASE for its customers and employees.

RAYLASE reserves the right to change the product described in this manual and the information contained therein without prior notice.

The software included in the product and this manual itself are protected by copyright. All rights are reserved. Duplication of this manual in whole or in part, particularly by photocopying, scanning or imaging, and reproduction by any means are forbidden without the prior, written consent of RAYLASE.

**CONTENTS**

**1 BASIC SAFETY INSTRUCTIONS ..... 4**

1.1 Laser safety ..... 4

1.2 Laser shutter ..... 4

1.3 Signs ..... 4

1.4 Classification of laser devices ..... 5

1.5 Laser area ..... 6

**2 BASIC INFORMATION ..... 7**

2.1 Introduction ..... 7

2.2 Package contents ..... 7

2.3 Module overview ..... 8

2.4 Warranty ..... 9

2.5 Manufacturer ..... 9

2.6 Customer support ..... 9

2.7 Status LEDs ..... 10

**3 TECHNICAL DATA ..... 11**

3.1 Conformity with directives ..... 11

3.2 Rating plate code ..... 11

3.2.1 Primary Name ..... 11

3.2.2 Detailed Description ..... 12

**4 FUNCTIONAL DESCRIPTION ..... 13**

4.1 Laser beam deflection unit ..... 13

4.2 F-Theta lens ..... 14

4.3 Digital interface ..... 15

4.4 Power supply ..... 16

**5 INSTALLATION ..... 17**

**6 MAINTENANCE AND CLEANING ..... 18**

6.1 Cleaning the housing ..... 18

6.2 Cleaning the optical system ..... 18

6.2.1 Instructions for cleaning lenses and glass guards ..... 19

6.2.2 Instructions for cleaning mirrors ..... 19

6.2.3 Special instructions for zinc selenide optical elements ..... 19

**7 TROUBLESHOOTING ..... 21**

# 1 BASIC SAFETY INSTRUCTIONS

## 1.1 Laser safety

The user is responsible for safe operation and for safeguarding the surrounding area against hazards that can be caused by laser radiation. OEM customers must ensure compliance with all local and national regulations.

## 1.2 Laser shutter

The deflection unit is designed to deflect an input laser beam and output it again.

The deflection unit cannot block or weaken the laser beam. To prevent unwanted emission of the laser beam, above a particular danger class the laser device must be fitted with a shutter (⇒ page 5, Classification of laser devices).

The laser device must be of sufficient quality that the laser beam can only be emitted at the beam output on the deflection unit.

## 1.3 Signs

The following signs must be attached to the deflection unit. These signs may not be removed. Signs that have become illegible must be replaced.

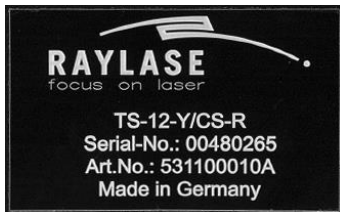

### Rating plate

The rating plate and the identification code printed on it allow the type of the deflection unit to be determined (⇒ page 11, **Rating plate code**). The serial number and the item number are also used to identify the deflection unit.



The **CE symbol** confirms the deflection unit's compliance with European directives. It indicates that the deflection unit is approved for free trade within the EU.

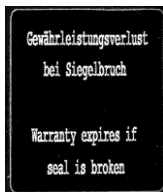

The **seal label** warns against unauthorized opening of the deflection unit. If the seal is broken, all warranty claims against RAYLASE are void.



At the point where laser radiation is emitted, a **laser warning sign** must be attached. It provides information about the type of radiation, specific hazards and the degree of protection. The laser warning sign is attached by the OEM customer in accordance with the laser device's classification (⇒ page 5, Classification of laser devices).

## 1.4 Classification of laser devices

The deflection unit can be fitted on various laser devices. Every laser device is assigned to a particular danger class, which must be specified at the point where laser radiation is emitted, e.g. using a warning sign. The following classifications are defined in DIN EN 60825-1:

Class	Description
1	The accessible laser radiation is not dangerous under reasonable foreseeable conditions.
1M	The accessible laser radiation is in the wavelength range of 302.5 to 4,000 nm. The accessible laser radiation is not dangerous to the eyes, as long as the cross-section is not reduced by optical instruments (magnifying glasses, lenses, telescopes).
2	The accessible laser radiation is in the visible spectrum (400 to 700 nm). Short-term exposure (up to 0.25s) is not dangerous to the eyes. Additional radiation components outside the wavelength range from 400-700 nm meet the requirements for class 1.
2M	The accessible laser radiation is in the visible spectrum from 400 to 700 nm. Short-term exposure (up to 0.25s) is not dangerous to the eyes, as long as the cross-section is not reduced by optical instruments (magnifying glasses, lenses, telescopes). Additional radiation components outside the wavelength range from 400-700 nm meet the requirements for class 1M.
3R	The accessible laser radiation is in a wavelength range of 302.5 to 10,600 nm and is dangerous to the eyes. The power or energy is a maximum of five times the limit for permissible class 2 radiation in the wavelength range from 400 to 700 nm.
3B	The accessible laser radiation is dangerous to the eyes and frequently to the skin.
4	The accessible laser radiation is extremely dangerous to the eyes and dangerous to the skin. Even diffuse scattered radiation can be dangerous. The laser radiation can cause fires or a risk of explosion.

**Note:** Bear in mind that the deflection unit changes the position at which the beam is emitted and the new beam output must be marked with a warning sign showing the appropriate classification.

**Note:** The deflection unit can change the classification of the laser device, particularly if it is fitted with a focusing lens. The laser device may require additional protective equipment as a result.

## 1.5 Laser area

For the purposes of accident prevention, the laser area is defined as the area in which the maximum permitted radiation value can be exceeded. This is generally applicable for class 3B, 3R and 4 lasers. For class 1 to 2M laser devices, a laser area can be produced by focusing the laser beam.

A sufficient beam intensity produces a laser area that covers the entire radiation angle of the deflection unit and includes the reflection from all objects that can be exposed to the radiation as a result. Note that even apparently diffuse surfaces can reflect laser radiation and a laser beam that has been reflected several times can still be dangerous.

The laser area must be indicated by corresponding warning signs or lamps and protected by appropriate shading and interlock switches.

No flammable or explosive objects or liquids should be located in the laser area.

This operating manual interprets a selection of accident prevention regulations from the point of view of using laser deflection units in industrial plants. However, the applicable local and national standards, rules and regulations are binding.

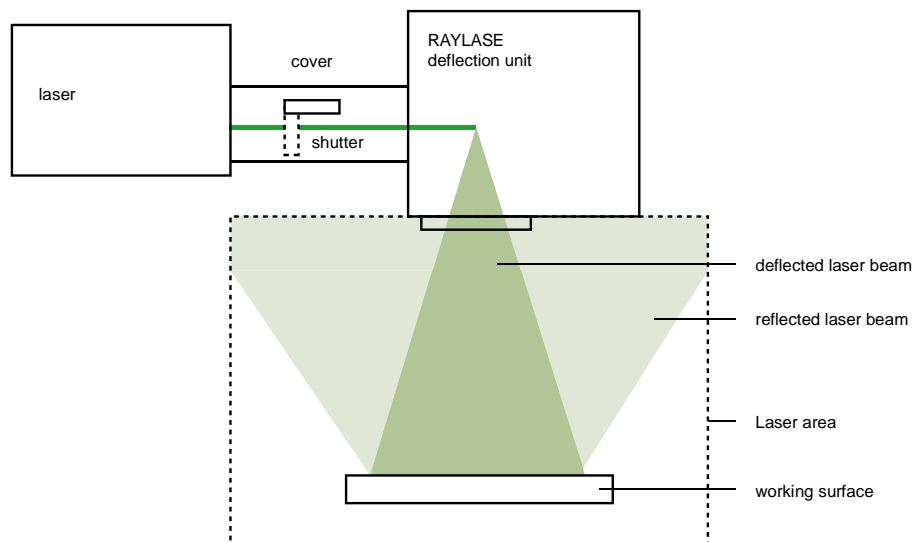

## 2 BASIC INFORMATION

### 2.1 Introduction

This operating manual describe the general handling of deflection units from the following series: SUPERSCAN III. For details of the type you are using, refer to the rating plate.

This operating manual contains important information on qualified and safe handling of the deflection unit. You should therefore familiarize yourself with the content of this manual before using the deflection unit for the first time. In case of any queries, please contact RAYLASE.

The operating manual must be accessible to anyone who will be involved in developing, installing or using a laser device featuring the RAYLASE deflection unit. If the deflection unit is sold on, this operating manual or an authorized copy must be passed on with it.

### 2.2 Package contents

Standard:

- Deflection unit

Optional:

- F-Theta lens, glass guard
- Control card
- Connecting cable between control card and deflection unit
- Software package

### 2.3 Module overview

The illustration below shows three typical laser devices that are realized using RAYLASE and customer-specific modules (indicated by dotted lines).

**Fig. 1**  
Module overview

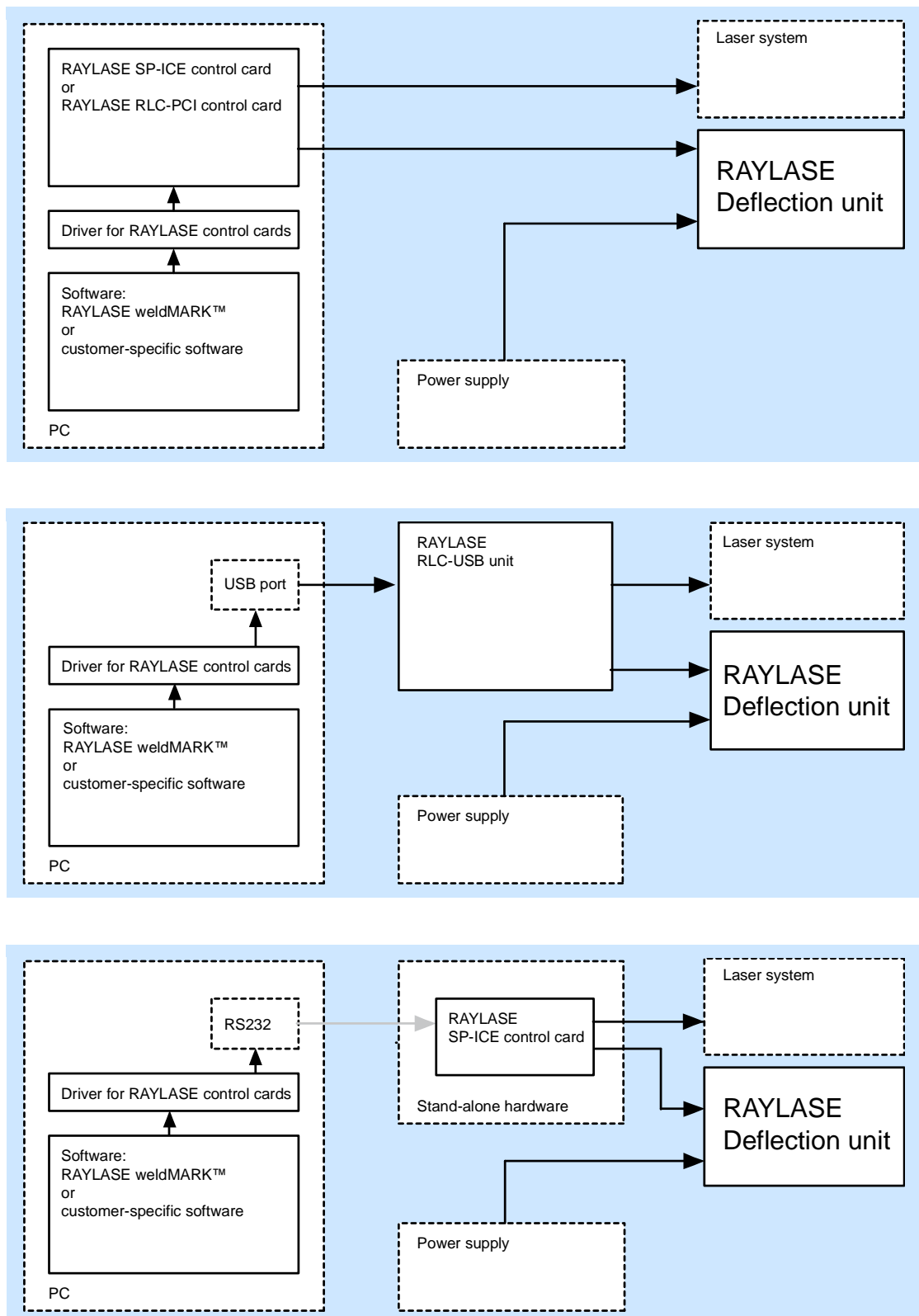



## 2.4 Warranty

The rights of the customer in respect of any defects in quality or deficiencies in title are governed by the general conditions of business of RAYLASE AG. These conditions are available for review on our website.

Before returning the product, please request an authorization number from RAYLASE. Pack the product in the original packaging or in packaging that provides equivalent protection for shipping.

RAYLASE shall not be obliged to repair defects under the following circumstances:

- If persons not authorized by RAYLASE have attempted to repair the product.
- If persons not authorized by RAYLASE have modified the product.
- If the product has been used improperly.
- If the product has been connected to incompatible devices.
- If the product has been damaged because of inadmissible high laser power or focusing the laser on optical areas.
- If the product has been damaged because of unqualified cleaning of the optical areas.
- If the warranty period is expired.

**Note:** No implicit guarantee or warranty of suitability for specific purposes has been made. RAYLASE is not responsible for damages arising from use of the product. Individual assemblies or other assemblies manufactured by RAYLASE may be subject to separate warranty conditions. Refer to the corresponding manuals for further information.

## 2.5 Manufacturer

RAYLASE AG  
Argelsrieder Feld 2+4  
82234 Wessling  
Germany  
Tel.: +49 (0) 81 53 - 88 98 - 0  
Fax: +49 (0) 81 53 - 88 98 - 10  
<http://www.raylase.de>  
E-mail: [info@raylase.de](mailto:info@raylase.de)

## 2.6 Customer support

The RAYLASE support services are available for your problems either in respect to the deflection unit or this manual. Before calling for support, please make sure you refer to any appropriate sections in the manuals on the supplied CD that may answer your questions.

If you need further assistance call RAYLASE customer service department, Monday through Friday between 8 A.M. and 5 P.M. (Middle European Time).

The customer service personnel will be able to give you direct assistance and answers to your questions.

Germany (Wessling)  
+49 (0) 81 53 - 88 98 – 0  
E-Mail: [support@raylase.de](mailto:support@raylase.de)

... ask for the customer service department

## 2.7 Status LEDs

The status LEDs allow you to check important functions and statuses on the deflection unit. They are located on the front or on the top of the deflection unit (depends on type).

LED arrangement	Name	Color	Meaning
	PY	red	CLK fault
	PX	red	Parity fault X
	EY	red	Parity fault Y
	EX	red	Temp. status X
	DY	yellow	Temp. status Y
	DX	yellow	New data X
	OY	green	New data Y
	OX	green	Fault X
	P-	green	Fault Y
	P+	green	
	L-	green	+VCC
	L+	green	-VCC

### 3 TECHNICAL DATA

This section outlines the common features of all deflection units. For type-specific features, refer to the data sheets in the Appendix. The individual data is assigned by the rating plate on the deflection unit and by the identification code (⇒ below, Rating plate code).

#### 3.1 Conformity with directives

The deflection unit conforms to the requirements of the following directives:

- EU Directive 2004/108/EG or German law on electromagnetic compatibility (EMVG)
- EU Directive 2002/95/EC or German law on electrical equipment (ElektroG)
- Directive 2006/42/EC on machinery
- For details of conformity with other directives, contact RAYLASE.

#### 3.2 Rating plate code

With the rating plate code, the properties of the deflection units can be determined. Please check before installation whether the deflection unit is suitable for the intended use.

##### 3.2.1 Primary Name

With the primary name on the rating plate of the product group, the type, the aperture and the intended wavelength of the deflection unit can be determined.

Type Designation  
 MS = MiniScan  
 SS = SuperScan  
 TS = TurboScan  
 AS = AxialScan  
 FS = FocusShifter  
 LT = LTM Modul

<b>Type</b>	
I	= Series
II	= Series
III	= Series
E	= Enhanced
<b>Aperture</b>	
07...70 [mm]	
<b>Wavelength</b>	
[AL]	= 193nm
[TY]	= 355nm
[405]	= 405nm
[AG]	= 400nm to 1064nm
[AR]	= 488nm to 514nm
[DY]	= 532nm
[DY+Y]	= 532nm & 1064nm
[780-980]	= 780nm to 980nm
[780-980+AL]	= 780nm to 980nm & 193nm
[850-870+Y]	= 850nm to 870nm & 1064nm
[900-1030+AL]	= 900nm to 1030nm & 193nm
[900-1100+AL]	= 900nm to 1100nm & 193nm
[915+975]	= 915nm & 975nm
[975]	= 975nm
[975+985+AL]	= 975nm & 985nm & 193nm
[Y]	= 1064nm
[AU]	= 10600nm
[C]	= 10600nm

**Additional information or customer shortcut**  
 ↓

GG-TTTT-AA [WWWWWWWWWWW]/D

**Note:** All mirrors in addition to the above coatings have a deflector for the wavelength 633nm.

### 3.2.2 Detailed Description

With the detailed description on the rating plate, the mirror material, the type of cooling, the size of the aperture, the type of tuning, the type of connector can be determined. Moreover, the rating plate remains the individual customer number.

Mirror Material  
 BE = beryllium  
 BA = beryllium/alu  
 QU = quarz  
 SI = silicon  
 SC = silicon carbide

#### Cooling

[N] = no cooling  
 [W] = water cooling  
 [W2] = water cooling with 90 ° angle  
 [A] = air-cooled  
 [WA] = water or air cooling  
 [W2A] = water or air cooling with 90 ° angle

#### Tuning

LN = low noise  
 RA = short acceleration time  
 ST = minimal step time  
 VC = vector  
 ML = multiple tuning (default: LN)  
 MR = multiple tuning (default: RA)  
 MS = multiple tuning (default: ST)

#### Connector

D1 = 25-pin D-Sub-plug  
 D2 = 25-pin D-Sub-plug + 9-pol D-Sub-plug  
 DF = D-Sub for Focus Shifter  
 A1 = 25-pin D-Sub-plug  
 A2 = 25-pin D-Sub-plug + 9-pol D-Sub-plug

#### Navision customer number

SS-[KKK]-TT-CC/DKdNr

## 4 FUNCTIONAL DESCRIPTION

### 4.1 Laser beam deflection unit

The deflection unit can be used to deflect a laser beam in X and Y directions. This produces an area within which a laser can be directed at any position. This area is known as the "marking field" and is shown in Fig. 2. Deflection is performed by two mirrors, each of which is moved by a galvanometer scanner. The deflection unit has a beam input, into which the laser beam is fed, and a beam output, through which the laser beam is emitted from the unit after deflection. Only suitable lasers can be fed into the beam input. Refer to the corresponding data sheet in the Appendix for details. Depending on the version, the beam output is either open or fitted with an F-Theta lens or glass guard (⇒ page 14, F-Theta lens).

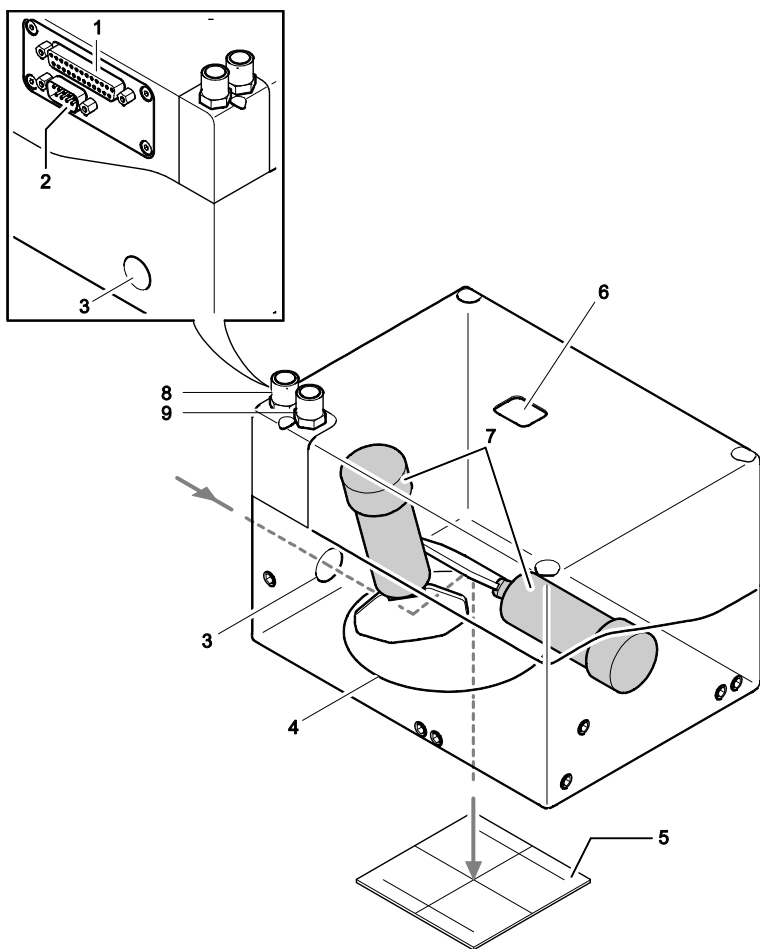

**Fig. 2**  
Functional principle

- 1 Digital interface
- 2 Power supply
- 3 Beam input
- 4 Beam output
- 5 Operating field
- 6 Status LEDs
- 7 Galvanometer scanners with mirrors

- Only for deflection units with water cooling
- 8 Input coolant
  - 9 Output coolant

Only for deflection units fitted with an F-Theta lens

## 4.2 F-Theta lens

The F-Theta lens is specially designed for use with 2-axis deflection units. It focuses the laser beam at optimum quality on any position in the marking field. At the same time, it provides partial optical compensation for the barrel-shaped distortion that is unavoidable when using a two-axis deflection unit. The remaining distortion (see below) must be compensated by the deflection unit drive.

**Fig. 3**  
Field distortion  
with and without  
F-Theta lens

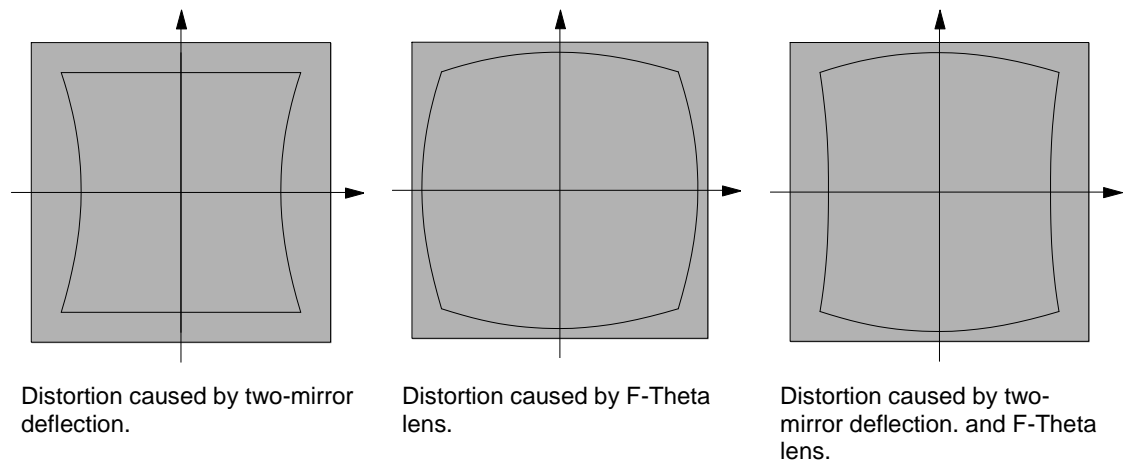

**Fig. 4**  
Example: F-  
Theta lens for  
Nd:YAG

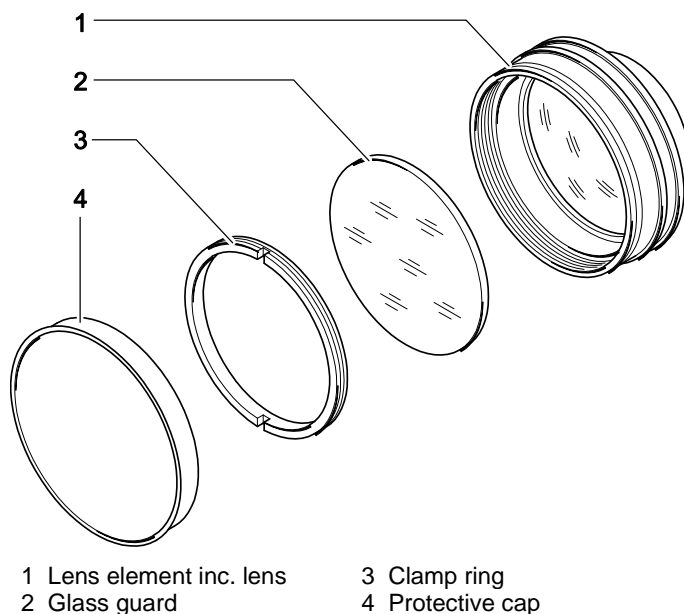

### Assembly instructions

- Before installation, check the protection window for dirt, scratches or cracks.
  - If the protection window is dirty, it must be cleaned (⇒ page 19, Instructions for cleaning lenses and glass guards).
  - If the protection window is scratched or cracked, it must be replaced.
- Brush the outer thread of the protective glass with a small amount of special grease for photo-mechanical components. Normal fats are not suitable because they release gases and thus the optical system can be destroyed.
- Screw the protection window and mount into the beam output on the deflection unit until it is positioned securely.

### 4.3 Digital interface

The deflection unit is connected to a RAYLASE control card using the 25-pin D-SUB connector. All signals are compatible with RAYLASE's extended function XY2-100 standard.

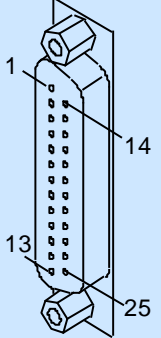
J1	PIN	Signal	PIN	Signal
 <p>25 PIN D-SUB</p>	1	I -SENCLOCK	14	I +SENCLOCK
	2	I -SYNC	15	I +SYNC
	3	I -X CHANNEL	16	I +X CHANNEL
	4	I -Y CHANNEL	17	I +Y CHANNEL
	5	I -Z CHANNEL	18	I +Z CHANNEL
	6	O -Y STATUS	19	O +Y STATUS
	7	O -Z STATUS	20	O +Z STATUS
	8	O -X STATUS	21	O +X STATUS
	9	nc	22	nc
	10	nc	23	GND
	11	GND	24	GND
	12	nc	25	nc
	13	nc	---	---

I = Diff. Input, nc = Not connected (not used) O = Diff. Output

#### Specifications

Diff. Input-, Diff. Input+		Diff. Output-, Diff. Output+	
Input voltage	0V to +5V	Output low	max. 0.6V max. 40mA
Input threshold	±200mV	Output high	min. 2V @ 50Ω max. 40mA
Hysteresis	typ. 45mV	ESD protection	±10kV
Input impedance	120Ω		
ESD protection	±15kV		

## 4.4 Power supply

The 9-pin D-SUB connector provides the deflection unit with power. The power supply must be provided by the OEM customer. Refer to the following connection and parameter table:

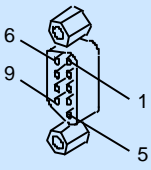
J1	PIN	Designation	Voltage	Current	Residual ripple	Noise
 9 PIN D-SUB	1, 2, 6	-VSS	-15V to -18V	min. 2.5A	≤100mV	≤0.5% DC at 30MHz
	4, 5, 9	+VSS	+15V to +18V	min. 2.5A		
	3, 7, 8	GND				



## 5 INSTALLATION



### Warning:

- The laser beam can cause severe injury to the eyes and the skin. Note that even apparently matt objects can reflect the wavelength of laser beams. All personnel in the room must wear appropriate laser protection goggles and, if necessary, protective clothing.
- Never look directly at the laser beam, even when wearing protective goggles.
- The deflection unit may require the laser device to be assigned to a different danger class (⇒ page 5, Classification of laser devices).
- The laser must be switched off during installation.
- We recommend that the laser area is completely protected by an appropriate working chamber. If this is not possible, appropriate protective measures for the laser class must be implemented.
- The mirrors in the deflection unit must move freely after installation of the deflection unit. No components of the laser device may protrude into the deflection unit.
- The laser device must be of sufficient quality that the laser beam can only be emitted at the beam output on the deflection unit.
- The "Laser radiation" national accident prevention regulations must be observed.
- Connecting cables may not be subjected to mechanical strain.
- The deflection unit must be protected against moisture, dust and corrosive vapors.
- The optical components may only be touched when wearing suitable cotton gloves.
- The deflection unit must be protected against static discharge and strong electromagnetic fields.
- The power density of the input laser radiation may not exceed the maximum permissible power density of the optical components of the deflection unit.
- The beam path and the function of the deflection unit must be tested after installation.

We recommend performing all tests with a danger class 1 or 2 laser to minimize the risk of injury. If this is not possible, the laser used must be set to the lowest possible power. This setting must be secured against accidental adjustment.

### Procedure

- Carefully remove the protective cover over the beam input with a small screwdriver.
- To install the deflection unit, insert locating pins into the corresponding holes and attach the deflection unit to the prepared installation surface using screws.  
**Note:** The deflection unit may only be installed using the pins and screws specified by RAYLASE. Follow the installation drawing supplied.
- For details of how to connect the deflection unit to a RAYLASE control card, refer to the corresponding manual.

## 6 MAINTENANCE AND CLEANING

The subsystem doesn't contain any components that require regular maintenance.

Repairs may only be carried out by RAYLASE or RAYLASE Certified Service Centres because special know-how and comprehensive testing methods are required.

RAYLASE offers worldwide certified service and repair centers. A service and repair center in your area, see [www.raylase.com](http://www.raylase.com).

### 6.1 Cleaning the housing



**Warning:**

The laser beam can cause severe injury to the eyes and the skin. Before cleaning, make sure that the laser device is switched off and secured against accidentally being switched on.

The deflection unit housing is dust proof. It can be cleaned with a duster. If it is very dirty, the duster can be moistened with a light and non-aggressive cleaning solution (e.g. soap solution).

### 6.2 Cleaning the optical system



**Warning:**

The laser beam can cause severe injury to the eyes and the skin. Before cleaning, make sure that the laser device is switched off and secured against accidentally being switched on.

Dirty optical surfaces result in increased absorption of the laser radiation. This can cause the dirt to heat up sufficiently for it to burn into the optical surfaces and permanently damage them.

The following circumstances can cause increased accumulation of dirt:

- The ambient atmosphere is contaminated with dirt, grease or other particles.
- Vapors and particles are produced while working.
- Talking, coughing or sneezing close to optical surfaces.

In general, all contamination of the optical system should be avoided wherever possible. However, as contamination cannot be completely avoided, the optical system must be cleaned at appropriate intervals. Regular checking and cleaning of the optical surfaces can prevent permanent damage.

**Note:** RAYLASE accepts no liability for damaged optical components!

**Note:** Damage caused during the laser process, e.g. when processing metals, is irreversible and cannot be resolved by cleaning.

For deflection units with lens and glass guard only

### 6.2.1 Instructions for cleaning lenses and glass guards



**Warning:**

The laser beam can cause severe injury to the eyes and the skin. Before cleaning, make sure that the laser device is switched off and secured against accidentally being switched on.

Fingerprints contain aggressive substances that can damage the optical surfaces. Optical surfaces should therefore only be touched when wearing suitable gloves or with a lens cleaning cloth.

- Only touch the optical elements when wearing suitable cotton gloves and only touch the edges.
- Blow loose particles from the surface with clean and oil-free compressed air. Note that the compressed air in workshops can contain oil particles and is therefore unsuitable for cleaning the optical system.
- Moisten a suitable lens cleaning cloth with ethanol suitable for cleaning optical components.
- Place one end of the moistened cloth on the optical system and slowly move it over the optical components. Do not exert any pressure and do not rub the optical components.
- Remove any remaining ethanol residue with a dry optical cloth.
- Repeat the procedure until the surface is completely clean. Use a new cleaning cloth for each repetition.

### 6.2.2 Instructions for cleaning mirrors



**Warning:**

The laser beam can cause severe injury to the eyes and the skin. Before cleaning, make sure that the laser device is switched off and secured against accidentally being switched on.

The mirror surfaces are extremely sensitive and may only be cleaned by experienced personnel. We strongly recommend sending the deflection unit in to RAYLASE for the mirrors to be cleaned, as opening of the deflection unit by unauthorized personnel voids the warranty.

However, if you do want to clean the mirrors yourself, follow the same procedure as for cleaning the lens but with even more care (⇒ above, Instructions for cleaning lenses and glass guards).

### 6.2.3 Special instructions for zinc selenide optical elements

Zinc selenide (ZnSe) is an inorganic orange material that can be used in different forms as an optical component (e.g. lenses, beam splitters, mirrors) in CO<sub>2</sub> laser systems.

#### Properties of zinc selenide

Melting point	1,520°C
Density	5.27g/cm <sup>3</sup> at 25°C
Solubility	Sensitive to water

To improve the optical properties of the material, zinc selenide is often given an anti-reflex coating that can contain thorium fluoride. Thorium is a  $\alpha$  emitter and is slightly radioactive. Thorium is potentially hazardous to health if it is inhaled or swallowed. As the coating containing thorium is enclosed between non-radioactive layers, there is no risk to the user under normal circumstances.

**Damage to zinc selenide optical elements**

Under normal circumstances, no special precautions are necessary when handling or storing zinc selenide.

In case of damage to a zinc selenide optical element or its anti-reflex coating, follow the instructions below.

**Damage to anti-reflex coating**

- Possible causes:
  - Coating coming into contact with water, acids or alkalis
  - Mechanical damage due to improper cleaning or handling
- Action:
  - Pack the optical elements in an airtight sealed plastic container.
  - Return the container to your supplier. The supplier is responsible for professional disposal of the material.

**Damage to optical element**

- Possible causes:
  - Contact with water, acid or alkali
  - Mechanical damage due to improper cleaning or handling
- Action:
  - Avoid inhaling dust!
  - Carefully collect up fragments and pack them in an airtight sealed plastic container.
  - Return the container to your supplier. The supplier is responsible for professional disposal of the material.

**Damage to optical element due to laser radiation**

- Cause:
  - Damage to optical element due to laser radiation (laser radiation is no longer completely transmitted but is absorbed into the element due to damage to the anti-reflex coating or contamination of the optical element)
- Action:
  - Switch off the laser device immediately!
  - Leave the room for at least 30 minutes!
  - Wear gloves and a mouth protector while performing the subsequent steps!
  - Carefully collect up all fragments and pack them in an airtight sealed plastic container.
  - Clean all contaminated components and surfaces with a damp cloth and pack the cleaning cloths in a sealed plastic container.
  - Return the containers to your supplier. The supplier is responsible for professional disposal of the material.

**Warning:** Because of the risks outlined, zinc selenide optical elements must be cleaned with special care and is performed entirely at your own risk!

## 7 TROUBLESHOOTING



**Warning:**

The laser beam can cause severe injury to the eyes and the skin.

- Never look directly or indirectly into the laser beam during troubleshooting.
- Do not disable any safety precautions to protect against laser radiation.
- Wear protective clothing and/or goggles appropriate for the relevant laser class.

In case of malfunctions, check whether the symptom and a possible remedy are included in the following checklist.

Problem	Possible cause and remedy	
Poor marking quality	Defective power supply	
	Incorrect marking parameters	
Marking quality has deteriorated	Lens dirty	⇒ page 19, Instructions for cleaning lenses and glass guards
	Mirror dirty	⇒ page 19, Instructions for cleaning mirrors
	Laser power decreasing	The RAYLASE weldMARK™ software can compensate for a loss of laser power. Menu: System > Global adjustments
	Marking parameters changed	
	Divergence optics changed	
Laser spot changed	Dirty lens	⇒ page 19, Instructions for cleaning lenses and glass guards
	Dirty or damaged mirrors	⇒ page 19, Instructions for cleaning mirrors
		Send deflection unit in for repair
	Laser system adjusted	
No laser beam, although process started from PC.	Beam path blocked.	Remove protective cover from beam input and/or output
	Laser drive fault	
	Fault in laser system	
The deflection unit only deflects the laser beam in one direction or not at all.	Data cable defective	⇒ page 10, Status LEDs
X and Y axis reversed	Incorrect cabling	

If the fault cannot be resolved, contact RAYLASE Customer Service for further assistance.

**INDEX**

<b>C</b>		<b>P</b>	
CE symbol .....	4	Package contents .....	7
Cleaning .....	18	Power supply .....	16
Conformity with directives.....	11	<b>R</b>	
Customer Service.....	9	Rating plate .....	4
Customer Support .....	9	<b>S</b>	
<b>D</b>		Safety instructions .....	4
Digital interface.....	15	Seal label.....	4
<b>F</b>		Shutter.....	4
Functional description.....	13	Signs.....	4
<b>I</b>		Status LEDs.....	10
Installation .....	17	<b>T</b>	
<b>L</b>		Technical data .....	11
Laser beam deflection unit .....	13	Troubleshooting.....	21
Laser safety .....	4	<b>W</b>	
<b>M</b>		Warranty .....	9
Manufacturer .....	9	<b>X</b>	
		XY2-100 Standard .....	16

## SUPERSCAN-III-10

### General Specifications

Power Supply	Voltage	±15 V	Typical Deflection (Optical)	±0.393 rad
	Current	3 A, RMS, Max.10 A	Resolution XY2-100-E 16-Bit (mech./ optical)	6 / 12 µrad
	Ripple Noise	Max. 200 mVpp, @ 20 MHz bandwidth	Resolution 18-Bit RAYLASE mode (mech./ optical)	1.5 / 3 µrad
Ambient Temperature		+15 to+35 °C	Repeatability (RMS)	< 25 µrad
Storage Temperature		≤ 80 % non-condensing	Max. Gaindrift <sup>1)</sup>	< 15 ppm/K
Interface Signals Digital		XY2-100-Enhanced Protocol XY2-100 Protocol	Max. Offsetdrift <sup>1)</sup>	< 10 µrad/K
			Long-term Drift <sup>1),2)</sup>	< 60 µrad
			Position noise (RMS)	< 8 µrad

1) Drift per axis, 2) after warming-up, variations of ambient temperature < 1K 3) With water tempering at 4.5l/min and 22°C water temperature after 0.5 h warm-up

### Aperture Dependent Specifications – Mechanical Data

	SS-III-10
Input Aperture [mm]	10.0
Beam Displacement [mm]	12.4
Weight, (without objective) [kg]	ca. 2.9
Dimension (mm) (L x W x H)	170 x 125 x 126

### Aperture Dependent Specifications - Mirror Variations

Wavelengths	SS-III-10
355 nm	SI
532 nm	SI
780 - 980 nm + AL	
1064 nm	SI
900 - 1100 nm + AL	
1060 – 1080 nm	
10600 nm	SI

QU = Quarz (Fused Silica), SI = Silicium, SC = Silicium Carbide, BE = Beryllium

### Type Dependent Specifications – Tuning:

Tuning	Description	Multiple Tuning
LN	Low Noise	ML <sup>1)</sup>
RA	Short acceleration time	MR <sup>1)</sup>
ST	Step tuning, minimal jump time	MS <sup>1)</sup>

1) Abbreviation for multiple tuning default setting

### Type Dependent Specifications – Dynamic Data:

	SS-III-10		
Mirror Type	SI		
Tuning	LN	RA	ST
Acceleration Time [ms]	0.21	0.19	-
Writing Speed [cps] <sup>1), 2)</sup>	850	1000	-
Positioning Speed [m/s] <sup>1)</sup>	12	6	32
Tracking error [ms]	0.14	0.11	-
Step response time <sup>3)</sup>			
1 % of full scale [m/s]	-	-	0.32
10 % of full scale [m/s]	-	-	0.75

1) With F-Theta Lens f=163mm / field size 120 mm x 120 mm, 2) Single-stroke font with 1 mm height, 3) settling to 1/1000 of full scale

### Mirrors & Objectives

Scan mirrors and objectives with optimized mounts are available for all typical laser types, wavelengths, power densities, focal lengths and working fields. Customer specific configurations are also possible. Please contact the RAYLASE support team for specific information and possible combinations on +49-8153-8898-0 or email [support@raylase.de](mailto:support@raylase.de)

### Options

The SUPERSCAN III scan heads provide two types of water-tempering connections for the electronics and galvanometer scanners, Straight [W] connectors and 90° [W2] connectors along with air-cooling [A] of the deflection mirrors. This ensures constant working conditions and excellent long-term stability, thus guaranteeing reliable operation even in high-laser-power applications.

BE and SC mirrors allow for higher speed performance due to the lightweight mirror substrates and optimized mirror mounts.

### Water Tempering Specifications

Requirement		Flow rate	Pressure loss
Water <sup>1)</sup>	Clean tap water with additives	2 l / min	0.3 bar
Temperature	22-28°C	4 l / min	0.4 bar
Pressure	2-5 bar	6 l / min	0.7 bar

(1) **Caution:** When using cooling water including deionised water, suitable additives must be used to prevent the growth of algae and protect the aluminium parts against corrosion.

**Additive recommendations:** Standard industrial applications e.g. CCL105 (NALCO)

**Food & beverage, packaging applications:** e.g. polypropylene glycol (Dow Chemical)

Please consult your additive supplier for dosage information



# SUPERSCAN-III-15

## General Specifications

Power Supply	Voltage	±15 V	Typical Deflection (Optical)	±0.393 rad
	Current	3 A, RMS, Max.10 A	Resolution XY2-100-E 16-Bit (mech./ optical)	6 / 12 µrad
	Ripple Noise	Max. 200 mVpp, @ 20 MHz bandwidth	Resolution 18-Bit RAYLASE mode (mech./ optical)	1.5 / 3 µrad
Ambient Temperature		+15 to+35 °C	Repeatability (RMS)	< 2 µrad
Storage Temperature		≤ 80 % non-condensing	Max. Gaindrift <sup>1)</sup>	< 15 ppm/K
Interface Signals Digital		XY2-100-Enhanced Protocol XY2-100-Protocol	Max. Offsetdrift <sup>1)</sup>	< 10 µrad/K
			Long-term Drift <sup>1,2) 3)</sup>	< 60 µrad
			Position noise (RMS)	< 8 µrad

1) Drift per axis, 2) after warming-up, variations of ambient temperature < 1K 3) With water tempering at 4.5l/min and 22°C water temperature after 0.5 h warm-up

## Aperture Dependent Specifications – Mechanical Data

	SS-III-15
Input Aperture [mm]	15.0
Beam Displacement [mm]	18.1 <sup>1)</sup> / 18.6
Weight, (without objective) [kg]	ca. 2.9
Dimension (mm) (L x W x H)	170 x 125 x 126

1) Specification for QU fused Silica mirrors

## Aperture Dependent Specifications - Mirror Variations

Wavelengths	SS-III-15
355 nm	QU, SI
532 nm	QU, SI, BE
780 - 980 nm + AL	QU, SI
1064 nm	QU, SI, BE
900 - 1100 nm + AL	
1060 – 1080 nm	
10600 nm	SI, BE

QU = Quartz, SI = Silicium, SC = Silicium Carbid, BE = Beryllium

## Type Dependent Specifications – Tuning:

Tuning	Description	Multiple Tuning
LN	Low Noise	ML <sup>1)</sup>
RA	Short acceleration time	MR <sup>1)</sup>
ST	Step tuning, minimal jump time	MS <sup>1)</sup>

1) Abbreviation for multiple tuning default setting

## Type Dependent Specifications – Dynamic Data:

Mirror Type	SS-III-15								
	QU			SI			BE		
Tuning	LN	RA	ST	LN	RA	ST	LN	RA	ST
Acceleration Time [ms]	0.36	0.31	-	0.30	0.27	-	0.23	0.20	-
Writing Speed [cps] <sup>1), 2)</sup>	500	700	-	700	800	-	750	850	-
Positioning Speed [m/s] <sup>1)</sup>	8	6	32	12	6	32	12	6	32
Tracking error [ms]	0.22	0.19	-	0.18	0.15	-	0.15	0.12	-
<b>Step response time<sup>3)</sup></b>									
1 % of full scale [m/s]	-	-	0.55	-	-	0.5	-	-	0.4
10 % of full scale [m/s]	-	-	1.1	-	-	0.9	-	-	0.8

1) With F-Theta Lens f=163mm / field size 120 mm x 120 mm, 2) Single-stroke font with 1 mm height, 3) settling to 1/1000 of full scale

**Mirrors & Objectives**

Scan mirrors and objectives with optimized mounts are available for all typical laser types, wavelengths, power densities, focal lengths and working fields. Customer specific configurations are also possible. Please contact the RAYLASE support team for specific information and possible combinations on +49-8153-8898-0 or email [support@raylase.de](mailto:support@raylase.de)

**Options**

The SUPERSCAN III scan heads provide two types of water-tempering connections for the electronics and galvanometer scanners, Straight [W] connectors and 90° [W2] connectors along with air-cooling [A] of the deflection mirrors. This ensures constant working conditions and excellent long-term stability, thus guaranteeing reliable operation even in high-laser-power applications.

BE and SC mirrors allow for higher speed performance due to the lightweight mirror substrates and optimized mirror mounts.

**Water Tempering Specifications**

Specifications		Flow rate	Pressure loss
Water <sup>1)</sup>	Clean tap water with additives	2 l / min	0,3 bar
Temperature	22-28°C	4 l / min	0,4 bar
Pressure	2-5 bar	6 l / min	0,7 bar

(1) **Caution:** When using cooling water including deionised water, suitable additives must be used to prevent the growth of algae and protect the aluminium parts against corrosion.

**Additive recommendations:** Standard industrial applications e.g. CCL105 (NALCO)

**Food & beverage, packaging applications:** e.g. polypropylene glycol (Dow Chemical)

Please consult your additive supplier for dosage information

# SUPERSCAN-III-30

## General Specifications

Power Supply	Voltage	±15 V	Typical Deflection (Optical)	±0.393 rad
	Current	3 A, RMS, Max.10 A	Resolution XY2-100-E 16-Bit (mech./ optical)	6 / 12 µrad
	Ripple Noise	Max. 200 mVpp, @ 20 MHz bandwidth	Resolution 18-Bit RAYLASE mode (mech./ optical)	1.5 / 3 µrad
Ambient Temperature		+15 to+35 °C	Repeatability (RMS)	< 2 µrad
Storage Temperature		≤ 80 % non-condensing	Max. Gaindrift <sup>1)</sup>	< 15 ppm/K
Interface Signals Digital		XY2-100-Enhanced Protocol XY2-100-Protocol	Max. Offsetdrift <sup>1)</sup>	< 10 µrad/K
			Long-term Drift <sup>1,2) 3)</sup>	< 60 µrad
			Position noise (RMS)	< 8 µrad

1) Drift per axis, 2) after warming-up, variations of ambient temperature < 1K 3) With water tempering at 4.5l/min and 22°C water temperature after 0.5 h warm-up

## Aperture Dependent Specifications – Mechanical Data

	SS-III-30
Input Aperture [mm]	30.0
Beam Displacement [mm]	35.4 <sup>1)</sup> / 36.0
Weight, (without objective) [kg]	ca. 5.5
Dimension (mm) (L x W x H)	203 x 159 x 150/160.5 <sup>2)</sup>

1) Specification for fused Silica mirrors, 2) AXIALSCAN variation only, additional output plate for protection window

## Aperture Dependent Specifications - Mirror Variations

Wavelengths	SS-III-30
355 nm	
532 nm	QU
780 - 980 nm + AL	QU
1064 nm	QU, SI, SC, BE
900 - 1100 nm + AL	SC
1060 – 1080 nm	QU, SC
10600 nm	SI, SC, BE

QU = Quarz (Fused Silica), SI = Silicium, SC = Silicium Carbid, BE = Beryllium

## Type Dependent Specifications – Tuning:

Tuning	Description	Multiple Tuning
LN	Low Noise	ML <sup>1)</sup>
RA	Short acceleration time	MR <sup>1)</sup>
ST	Step tuning, minimal jump time	MS <sup>1)</sup>

1) Abbreviation for multiple tuning default setting

## Type Dependent Specifications – Dynamic Data:

Mirror Type	SS-III-30											
	QU			SI			SC			BE		
Tuning	LN	RA	ST	LN	RA	ST	LN	RA	ST	LN	RA	ST
Acceleration Time [ms]	0.90	0.77	-	0.85	0.76	-	0.60	0.52	-	0.56	0.49	-
Writing Speed [cps] <sup>1), 2)</sup>	200	250	-	200	250	-	400	600	-	400	600	-
Positioning Speed [m/s] <sup>1)</sup>	7	6	8	7	6	8	10	6	11	10	6	11
Tracking error [ms]	0.48	0.41	-	0.45	0.40	-	0.30	0.26	-	0.28	0.25	-
<b>Step response time<sup>3)</sup></b>												
1 % of full scale [m/s]	-	-	1.25	-	-	1.25	-	-	0.9	-	-	0.8
10 % of full scale [m/s]	-	-	2.25	-	-	2.0	-	-	1.8	-	-	1.6

1) With F-Theta Lens f=255 mm, 2) Single-stroke font with 1 mm height, 3) settling to 1/1000 of full scale

**Mirrors & Objectives**

Scan mirrors and objectives with optimized mounts are available for all typical laser types, wavelengths, power densities, focal lengths and working fields. Customer specific configurations are also possible. Please contact the RAYLASE support team for specific information and possible combinations on +49-8153-8898-0 or email [support@raylase.de](mailto:support@raylase.de)

**Options**

The SUPERSCAN III scan heads provide two types of water-tempering connections for the electronics and galvanometer scanners, Straight [W] connectors and 90° [W2] connectors along with air-cooling [A] of the deflection mirrors. This ensures constant working conditions and excellent long-term stability, thus guaranteeing reliable operation even in high-laser-power applications.

BE and SC mirrors allow for higher speed performance due to the lightweight mirror substrates and optimized mirror mounts.

**Air flushing Specifications**

Specifications		Flow rate	Air Pressure
Air	Clean air free of water & oil	100 l / min	1.0 - 1.5 bar

**Water Tempering Specifications**

Specifications		Flow rate	Pressure loss
Water <sup>1)</sup>	Clean tap water with additives	2 l / min	0,3 bar
Temperature	22-28°C	4 l / min	0,4 bar
Pressure	2-5 bar	6 l / min	0,7 bar

(1) **Caution:** When using cooling water including deionised water, suitable additives must be used to prevent the growth of algae and protect the aluminium parts against corrosion.

**Additive recommendations:** Standard industrial applications e.g. CCL105 (NALCO)

**Food & beverage, packaging applications:** e.g. polypropylene glycol (Dow Chemical)

Please consult your additive supplier for dosage information