



ULTRAFAST LASERS & SYSTEMS FOR SCIENCE

PRODUCT CATALOGUE

2020

ULTRAFAST LASERS & SYSTEMS FOR SCIENCE

PRODUCT CATALOGUE

2020



Femtosecond Solutions for Industry and Science

The key drivers at LIGHT CONVERSION are consistency, the persistent quest for corporate goals, close attention to clients' needs, and an assurance of the exclusive quality of the products developed by the company. We have been developing technologies that alter the worlds of science and industry. Using our knowledge, experience, and leading position, we strive for perfection and continued growth. On the day our company was founded, we chose the path of research and have been following it ever since. Investments into this field have opened up a doorway to global markets for us. For more than two decades, we have been searching for and discovering new ways to apply femtosecond laser technology. The clients of LIGHT CONVERSION range from research centers and labs and industrial corporations to medical companies.

What We Do

We are the world-leading manufacturer of wavelength-tunable femtosecond optical parametric amplifiers (OPA) based on our TOPAS and ORPHEUS series as well as diode pumped solid state femtosecond lasers PHAROS and CARBIDE.

Both PHAROS, the most versatile femtosecond laser amplifier on the market, and the ultra-compact and cost-efficient CARBIDE, feature market-leading output parameters along with a robust design attractive to both industrial and scientific customers.

With major industrial customers operating in display, automotive, LED, medical device, and other industries, the reliability of PHAROS and CARBIDE has been proven by hundreds of systems operating in 24/7 production environments. The lasers are mainly used for drilling and cutting of various metals, ceramics, sapphire, glass, and material ablation for mass-spectrometry. However, customers are always finding new ways for PHAROS and CARBIDE to make existing manufacturing processes more efficient.

To complement our laser amplifiers we offer a strong portfolio of femtosecond products: harmonic modules (provide pulses at 515, 343, 257 and 206 nm), OPAs (produce continuous tuning output from ~190 nm up to ~20 μm), HARPIA spectrometers, TiPA and GECO autocorrelators. All our products can be customized and fine-tuned to meet the most demanding applications.

Who We Are

Founded in 1994 in Vilnius, LIGHT CONVERSION is a privately-owned company with >300 employees. Our >6500 m² facility accommodates design, R&D, and production teams so that all key manufacturing processes are managed in-house.

With more than 4500 systems installed worldwide, LIGHT CONVERSION has established itself as an innovative producer of ultrafast optical devices and the largest manufacturer of femtosecond optical parametric amplifiers (OPAs) and non-collinear OPAs. In addition to selling our products via a wide range of distributors, we also provide our OEM devices for other major laser manufacturing companies.

Contents

FEMTOSECOND LASERS / 4

PHAROS

High Power and Energy Femtosecond Lasers / 4
– Automated Harmonics Generators / 8

CARBIDE

Femtosecond Lasers for Industry and Science / 10
– Scientific Interface Module for CARBIDE / 13
– Automated Harmonics Generators / 14

I-OPA

Industrial-grade Optical Parametric Amplifier / 15

BiBurst

Tunable GHz and MHz burst
with burst-in-burst capability / 9

EXAMPLES OF INDUSTRIAL APPLICATIONS / 19

OSCILLATORS / 22

FLINT

Femtosecond Yb Oscillators / 22

HARMONICS GENERATORS / 24

HIRO

Harmonics Generator / 24

SHBC

Second Harmonic Bandwidth Compressor / 26

ORPHEUS OPA / 28

ORPHEUS

Collinear Optical Parametric Amplifier / 28

ORPHEUS-ONE

Mid-IR Collinear Optical Parametric Amplifier / 30

ORPHEUS-F

Broad Bandwidth Hybrid Optical Parametric Amplifier / 32

ORPHEUS-N

Non-Collinear Optical Parametric Amplifier / 34

ORPHEUS-TWINS

Two Independently Tunable
Optical Parametric Amplifiers / 36

ORPHEUS-PS

Narrow Bandwidth Optical Parametric Amplifier / 38

TOPAS DEVICES / 40

TOPAS

Optical Parametric Amplifiers for Ti:Sapphire lasers / 40

NIRUVIS

Frequency Mixer / 43

OPCPA DEVICES / 44

ORPHEUS-OPCPA

Pumped by Pharos or Carbide lasers / 45

OPCPA-HR

High Pulse Repetition Rate OPCPA Systems / 46

OPCPA-HE

High Energy OPCPA Systems / 47

SPECTROMETERS / 48

HARPIA

Comprehensive Spectroscopic Systems / 48

HARPIA-TA

Ultrafast Transient Absorption Spectrometer / 50

HARPIA-TF

Femtosecond Fluorescence
Upconversion & TCSPC Module / 52

HARPIA-TB

Third Beam Delivery Module / 54

HARPIA

Microscopy Module / 56

HARPIA Software

Spectroscopy Data Analysis Software / 57

HARPIA DATA SAMPLES / 58

AUTOCORRELATORS / 60

GECO

Scanning Autocorrelator / 60

TIPA

Single-Shot Autocorrelator for
Pulse-Front Tilt and Pulse Duration Measurements / 62

LIST OF LOCAL DISTRIBUTORS / 64

PHAROS

High Power and Energy Femtosecond Lasers

FEATURES

- 190 fs – 20 ps tunable pulse duration
- 2 mJ maximum pulse energy
- 20 W output power
- 1 kHz – 1 MHz tunable base repetition rate
- Pulse picker for pulse-on-demand operation
- Rugged industrial grade mechanical design
- Automated harmonics generators (515 nm, 343 nm, 257 nm, 206 nm)
- Optional CEP stabilization
- Possibility to lock oscillator to external clock



PHAROS is a femtosecond laser system combining millijoule pulse energies and high average powers. PHAROS features a mechanical and optical design optimized for industrial applications such as precise material processing. Compact size, an integrated thermal stabilization system, and sealed design allow PHAROS integration into machining workstations. Laser diodes pumping Yb medium significantly reduces maintenance costs and provides a long laser lifetime. Software tunability of PHAROS allows the system to cover applications

normally requiring different classes of laser. Tunable parameters include pulse duration (190 fs – 20 ps), repetition rate (single pulse to 1 MHz), pulse energy (up to 2 mJ) and average power (up to 20 W). Its power level is sufficient for most material processing applications at high machining speeds. The built-in pulse picker allows convenient control of the laser output in pulse-on-demand mode. PHAROS compact and robust optomechanical design features stable laser operation across varying environments.

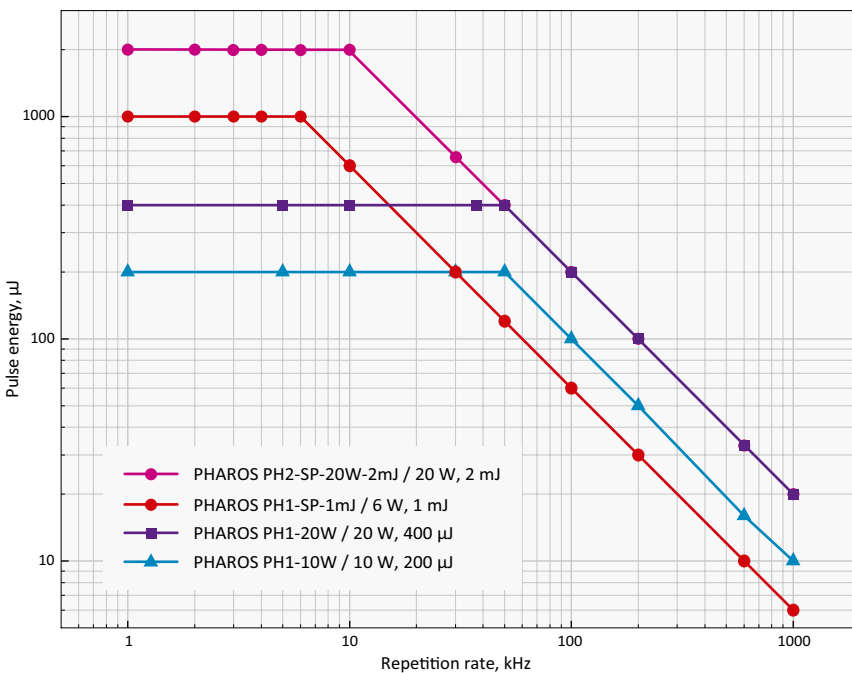

Pulse energy vs base repetition rate for PHAROS

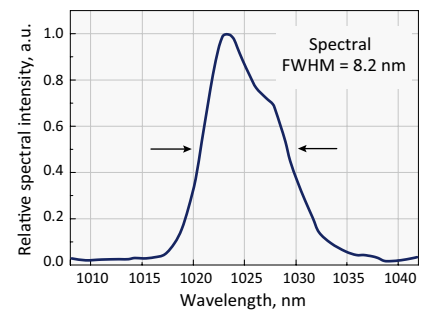

Typical spectrum of PHAROS

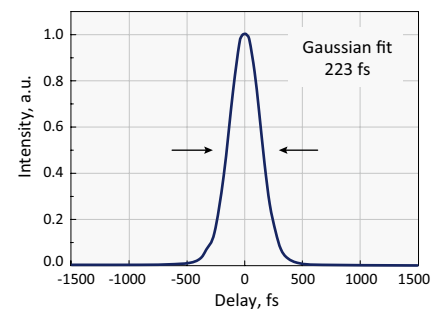

Typical pulse duration of PHAROS

SPECIFICATIONS

NEW

Model ¹⁾	PH1-10W	PH1-15W	PH1-20W	PH1-SP-1mJ	PH2-SP-20W-2mJ
---------------------	---------	---------	---------	------------	----------------

OUTPUT CHARACTERISTIC

Max. average power	10 W	15 W	20 W	6 W	20 W
Pulse duration (assuming Gaussian pulse shape)	< 290 fs			< 190 fs	
Pulse duration adjustment range	290 fs – 10 ps (20 ps on request)			190 fs – 10 ps (20 ps on request)	
Max. pulse energy	> 0.4 mJ			> 1 mJ	> 2 mJ
Fundamental repetition rate ²⁾	1 kHz – 1 MHz				
Pulse selection	Single-shot, Pulse-on-Demand, any base repetition rate division				
Centre wavelength ³⁾	1030 ± 10 nm				
Polarization	Linear, horizontal				
Beam quality	TEM ₀₀ ; M ² < 1.2			TEM ₀₀ ; M ² < 1.3	
Pulse-to-pulse energy stability ⁴⁾	RMS deviation ⁵⁾ < 0.5 % over 24 hours				
Output power stability	RMS deviation ⁵⁾ < 0.5 % over 100 h				
Beam pointing stability	< 20 µrad/°C				
Pre-pulse contrast	< 1 : 1000				
Post-pulse contrast	< 1 : 200				

OPTIONAL EXTENSIONS

Oscillator output	Optional. Please contact sales@lightcon.com for more details or customized solutions				
Typical output	1 – 6 W, 50 – 250 fs, ~1035 nm, ~ 76 MHz, simultaneously available				
Harmonics generator	Integrated, optional (see page 8)				
Output wavelength	515 nm, 343 nm, 257 nm, 206 nm				
Optical parametric amplifier	Integrated, optional (see page 15)				
Tuning range	640 – 4500 nm				
BiBurst mode	Tunable GHz and MHz burst with burst-in-burst capability, optional (see page 9)				
GHz-mode (P)					
Intra burst pulse separation ⁶⁾	~ 200 ± 40 ps			~ 500 ± 40 ps	
Max no. of pulses ⁷⁾	1 . . 25			1 . . 10	
MHz-mode (N)					
Intra burst pulse separation	~ 16 ns				
Max no. of pulses	1 . . 9, (7 with FEC)				

PHYSICAL DIMENSIONS

Laser head ⁸⁾	670 (L) × 360 (W) × 212 (H) mm	730 (L) × 419 (W) × 233 (H) mm
Rack for power supply & chiller	642 (L) × 553 (W) × 673 (H) mm	PS integrated in the laser head

ENVIRONMENTAL & UTILITY REQUIREMENTS

Operating temperature	15–30 °C (air conditioning recommended)	
Relative humidity	< 80 % (non condensing)	
Electric	110 V AC, 50–60 Hz, 20 A or 220 V AC, 50–60 Hz, 10 A	
Rated power	2000 W	1000 W
Power consumption	600 W	

¹⁾ More models are available on request.

²⁾ Some particular repetition rates are software-restricted due to system design.

³⁾ Precise wavelengths for specific models available upon request.

⁴⁾ Under stable environmental conditions.

⁵⁾ Normalized to average pulse energy.

⁶⁾ Custom spacing on request.

⁷⁾ Maximum number of pulses in a burst is dependent on the laser repetition rate. Custom number of pulses on request.

⁸⁾ Dimensions might increase for non-standard laser specifications.

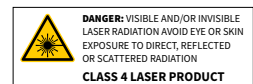

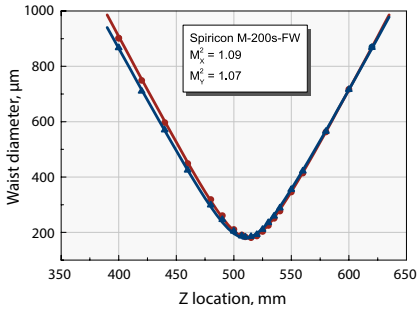

Typical M² measurement data of PHAROS

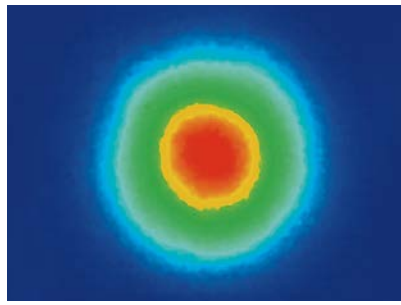

Typical near-field beam profile of PHAROS at 200 kHz

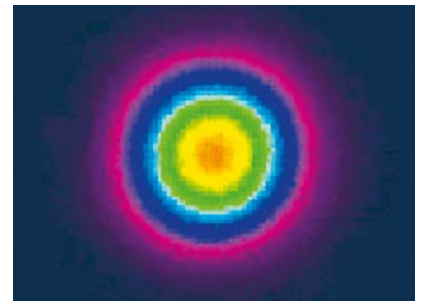

Typical far-field beam profile of PHAROS at 200 kHz

STABILITY MEASUREMENTS

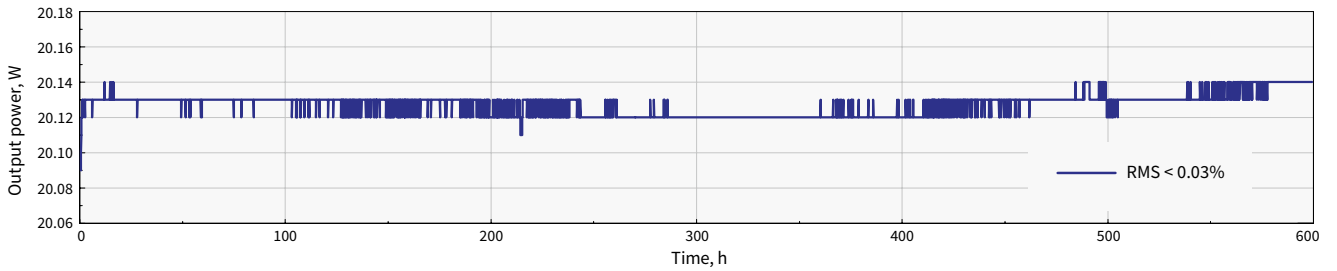

Long term stability graph of PHAROS

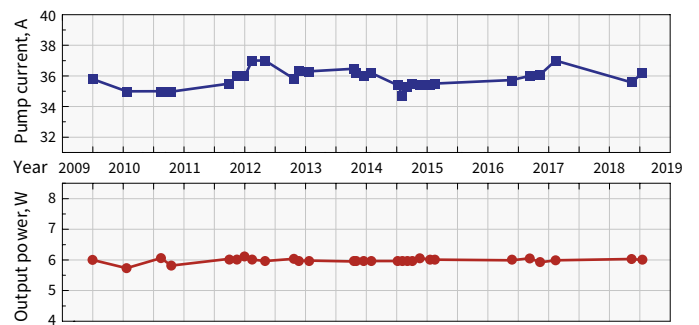
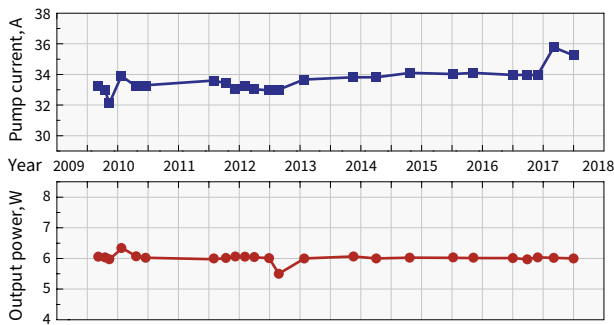

Output power of industrial PHAROS lasers operating 24/7 and current of pump diodes during the years

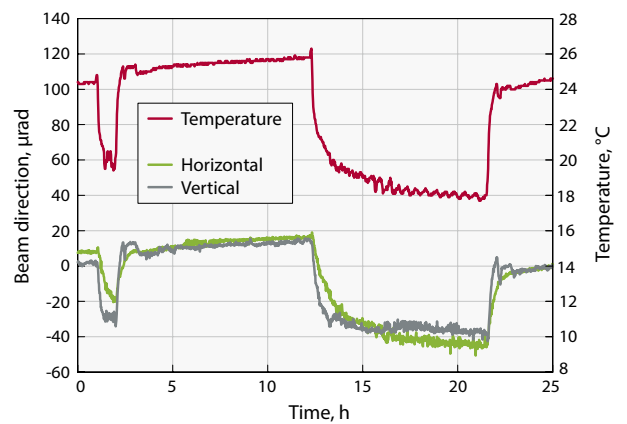
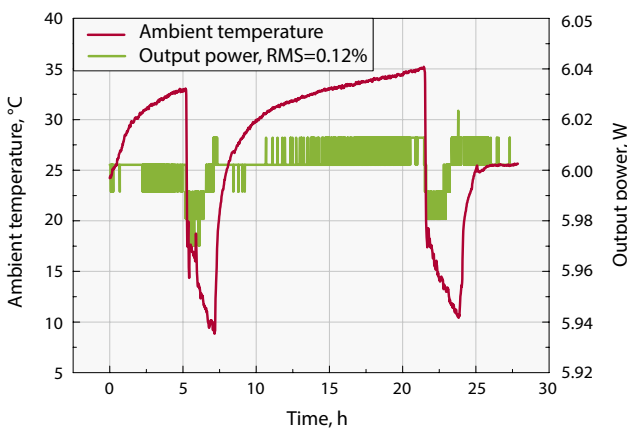

PHAROS output power with power lock enabled under unstable environment

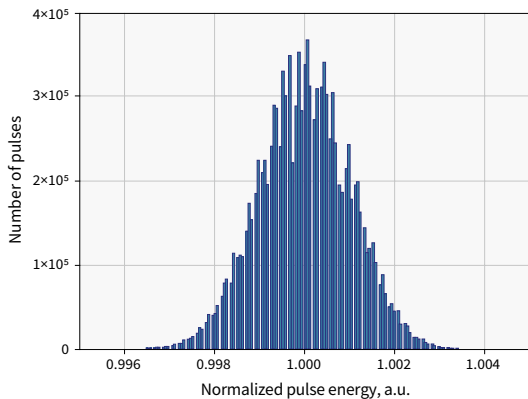

Short term pulse-to-pulse energy stability of PHAROS lasers. 1.2×10^7 pulses (1 min at 200 kHz), STD < 0.11%, peak-to-peak < 1%

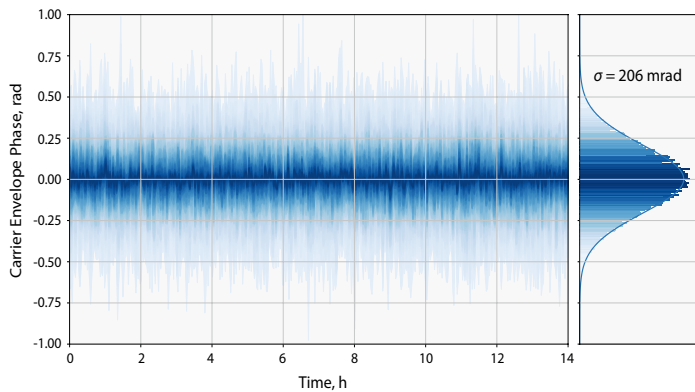

Carrier-envelope phase (CEP) over the long period with active phase stabilization system

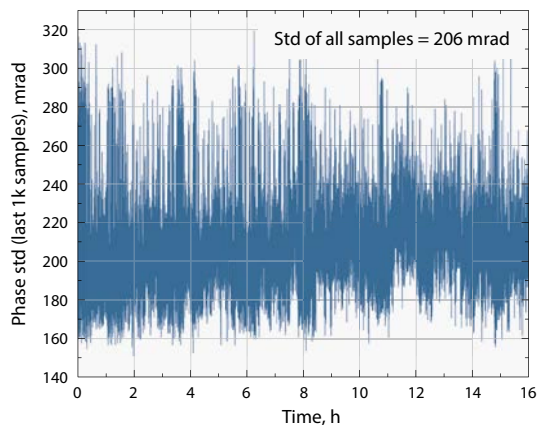

CEP stability over a long time scale

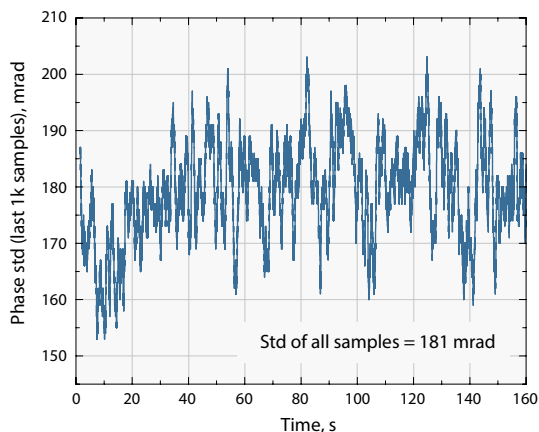

CEP stability over a short time scale

PHAROS CEP stability when laser is isolated from all noticeable noise sources – vibrations, acoustics, air circulation and electrical noise. System can achieve < 300 mrad std of CEP stability over a long time scale (> 8 hours) and < 200 mrad over a short time scale (< 5 min)

OUTLINE DRAWINGS

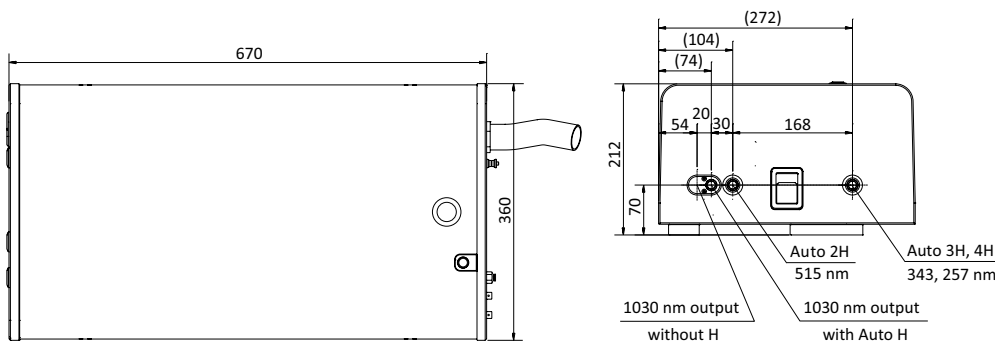

PHAROS-PH1 laser outline drawing

HG | PHAROS

Automated Harmonics Generators

FEATURES

- 515 nm, 343 nm, 257 nm and 206 nm
- Output selection by software
- Mounts directly on a laser head and integrated into the system
- Rugged industrial grade mechanical design



Harmonics generator module attached to PHAROS

PHAROS laser can be equipped with automated harmonics modules. A selection of fundamental (1030 nm), second (515 nm), third (343 nm), fourth (257 nm) or fifth (206 nm) harmonic outputs are available through software control.

Harmonics generators are designed to be used in industrial applications where a single output wavelength is desired. Modules are mounted directly on the output of the laser and integrated into the system.

SPECIFICATIONS

Model	2H	2H-3H	2H-4H	4H-5H
Output wavelength ¹⁾ (automated selection)	1030 nm 515 nm	1030 nm 515 nm 343 nm	1030 nm 515 nm 257 nm	1030 nm 257 nm 206 nm
Input pulse energy	20 – 2000 μJ	50 – 2000 μJ ²⁾	20 – 2000 μJ ²⁾	200 – 1000 μJ
Pump pulse duration	190 – 300 fs			
Conversion efficiency	>50 % (2H)	>50 % (2H) >25 % (3H)	>50 % (2H) >10 % (4H) ³⁾	>10 % (4H) ³⁾ >5 % (5H) ⁴⁾
Beam quality (M ²) ≤ 400 μJ pump	<1.3 (2H), typical <1.15	<1.3 (2H), typical <1.15 <1.4 (3H), typical <1.2	<1.3 (2H), typical <1.15 n/a (4H)	n/a
Beam quality (M ²) > 400 μJ pump	<1.4 (2H)	<1.4 (2H) <1.5 (3H)	<1.4 (2H) n/a (4H)	

¹⁾ Depends on pump laser model.

²⁾ High energy versions are available, please contact Light Conversion for specifications.

³⁾ Max 1 W output.

⁴⁾ Max 0.15 W output.

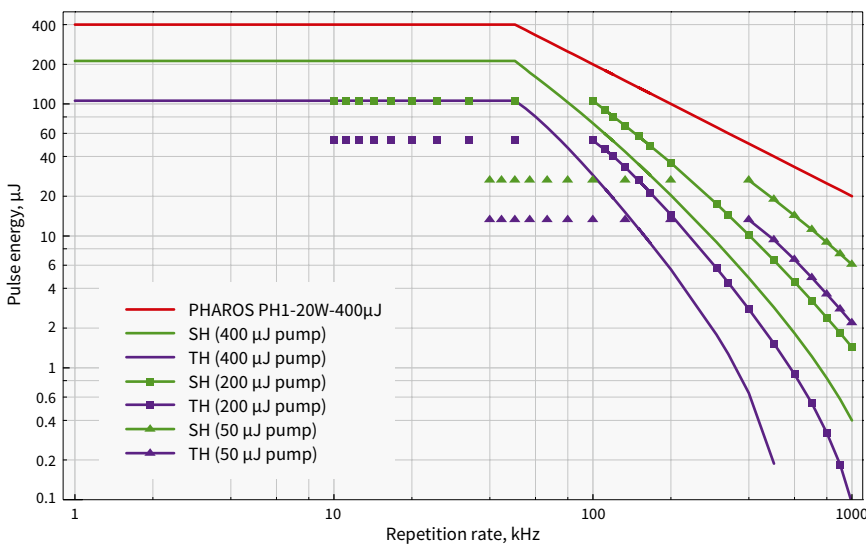
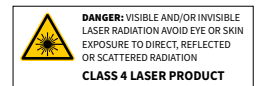

PHAROS harmonics energy vs pulse repetition rate

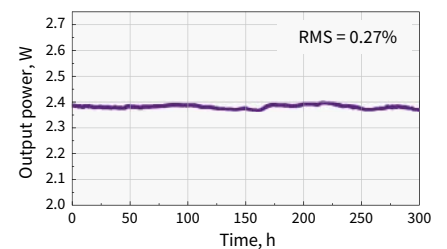

3H output stability

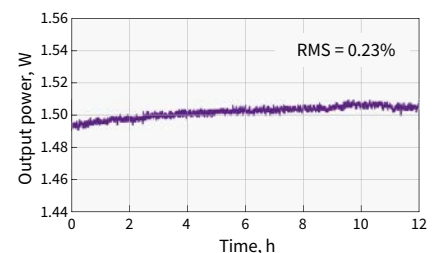

4H output stability

BiBurst

Tunable GHz and MHz burst with burst-in-burst capability

PHAROS and CARBIDE 40W (CB3) have an option for tunable GHz and MHz burst with burst-in-burst capability – called BiBurst. The distance between burst packet groups is called nanosecond burst, N (MHz-Burst). The distance between sub-pulses in the group is called picosecond burst, P (GHz-Burst).

In single pulse mode, one pulse is emitted at a time at some fixed frequency. In burst mode, the output consists of several picosecond burst packets each separated by an equal time period between each packet. Each packet can contain a number of sub-pulses which are also separated by an equal time period between each pulse.

High pulse energy femtosecond lasers PHAROS and CARBIDE with flexible BiBurst functionality bring new production capabilities to high-tech manufacturing industries such as consumer electronics, integrated photonic chip manufacturing, stent cutting, surface functionalization, future displays manufacturing and quantum computing.

BiBurst material fabrication areas cover:

- brittle material drilling and cutting
- deep engraving
- selective ablation
- transparent materials volume modification
- hidden marking
- surface functional structuring.

SPECIFICATIONS

Model		CARBIDE-CB3 (40 W)	PHAROS	PHAROS-SP
P, GHz-mode	Intra burst pulse separation ¹⁾	~440 ± 40 ps	~200 ± 40 ps	~500 ± 40 ps
	Max no. of pulses ²⁾	1 .. 10	1 .. 25	1 .. 10
N, MHz-mode	Intra burst pulse separation	~16 ns		
	Max no. of pulses	1 .. 10	1 .. 9, (7 with FEC)	1 .. 9, (7 with FEC)

¹⁾ Custom spacing on request.

²⁾ Maximum number of pulses in a burst is dependent on the laser repetition rate. Custom number of pulses on request.

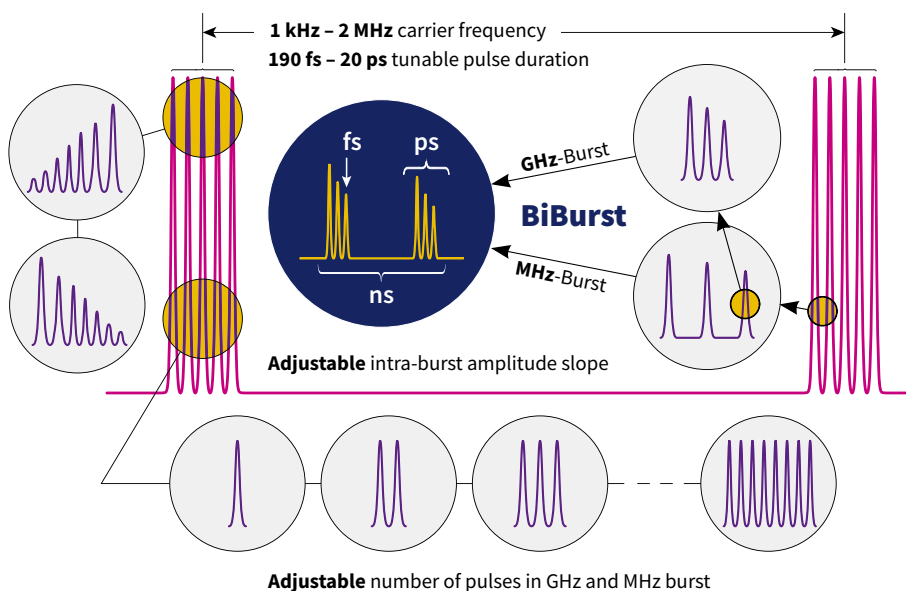

CARBIDE

Femtosecond Lasers for Industry and Science

FEATURES

- < 290 fs – 10 ps tunable pulse duration
- > 800 μJ pulse energies
- > 80 W output power
- 60 – 2000 kHz tunable base repetition rate
- Includes pulse picker for pulse-on-demand operation
- Rugged, industrial-grade mechanical design
- Air or water cooling
- Automated harmonics generators (515 nm, 343 nm, 257 nm)
- Scientific interface enhancing system flexibility



CARBIDE-CB3

CARBIDE femtosecond lasers feature an output power of >80 W at 1030 nm wavelength. The laser emits pure pulses with ASE background of $<10^{-9}$ and recently updated maximum energy specifications without compromises to the beam quality, industrial grade reliability and beam stability regardless of environmental conditions. Continuously tunable repetition rate in a range of 60 kHz to 2 MHz is combined with an in-built Pulse Picker for output pulse timing and full-scale energy control with <10 microsecond response time, enabling

arbitrary shaping of the emission. Pulse duration can be tuned in a range of 290 fs – 10 ps. Excellent power stability of <0.5 % RMS is standard. The laser output can be split into a burst of several pulses of pico- and nano- separation while having the ability to modify the burst envelope. Harmonic generator options permit femtosecond applications at different wavelengths. The parameters are entirely software adjustable.

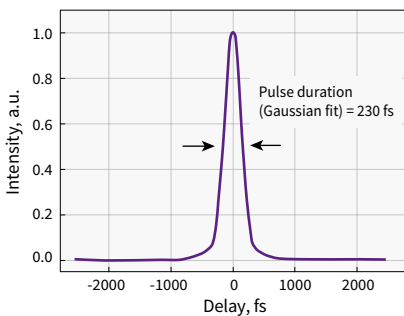

Typical pulse duration of CARBIDE laser

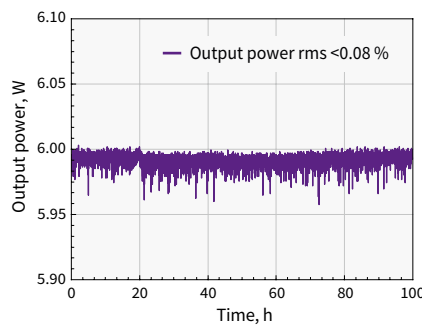

Long term power stability of CARBIDE-CB5

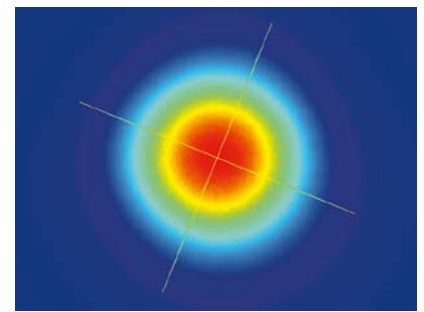

Typical beam profile of CARBIDE-CB5.
60 kHz, 5 W

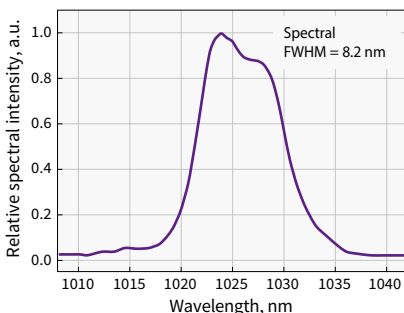

Typical spectrum of CARBIDE laser

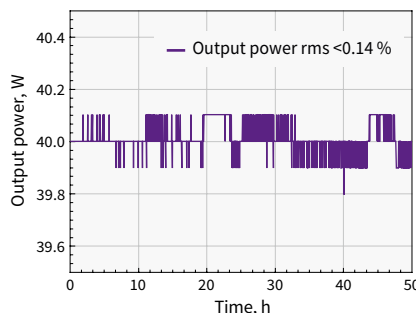

Long term power stability of CARBIDE-CB3

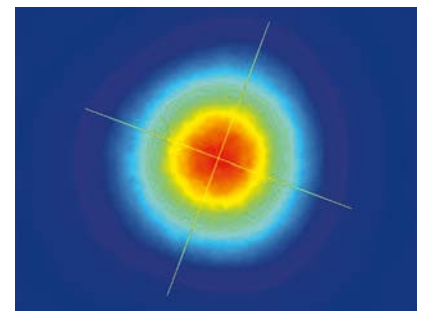

Typical beam profile of CARBIDE-CB3

SPECIFICATIONS

Model	CB3-40W	CB3-80W	NEW	CB5
-------	---------	---------	-----	-----

OUTPUT CHARACTERISTICS

Cooling method	Water-cooled		Air-cooled ¹⁾	
Max. average power	> 40 W	> 80 W	> 6 W	> 5 W
Pulse duration (assuming Gaussian pulse shape)	< 290 fs			
Pulse duration adjustment range	290 fs – 10 ps			
Max. pulse energy	> 0.4 mJ	> 0.8 mJ	> 100 µJ	> 83 µJ
Fundamental repetition rate ²⁾	100 – 2000 kHz		60 – 1000 kHz	
Pulse selection	Single-shot, Pulse-on-Demand, any base repetition rate division			
Centre wavelength ³⁾	1030 ± 10 nm			
Polarization	Linear, vertical			
Beam quality	TEM ₀₀ ; M ² < 1.2			
Pulse-to-pulse energy stability ⁴⁾	RMS deviation ⁵⁾ < 0.5 % over 24 hours			
Output power stability	RMS deviation ⁵⁾ < 0.5 % over 100 h			
Beam pointing stability	< 20 µrad/°C			
Pulse picker	FEC ⁶⁾	included	included	included, enhanced contrast AOM ⁷⁾
Pulse picker leakage	< 0.5 %	< 2 %	< 2 %	< 0.1 %

OPTIONAL EXTENSIONS

Harmonics generator	Integrated, optional (see page 14)			
Output wavelength	515 nm, 343 nm, 257 nm			
Optical parametric amplifier	Integrated, optional (see page 15)			
Tuning range	640 – 4500 nm			
BiBurst mode	Tunable GHz and MHz burst with burst-in-burst capability, optional (see page 9)			
GHz-mode (P)				
Intra burst pulse separation	~ 440 ± 40 ps ⁸⁾			
Max no. of pulses	1 .. 10 ⁹⁾		n/a	
MHz-mode (N)				
Intra burst pulse separation	~ 16 ns			
Max no. of pulses	1 .. 10			

PHYSICAL DIMENSIONS

Laser head	632 (L) × 305 (W) × 173 (H) mm	631 (L) × 324 (W) × 167 (H) mm
Power supply	280 (L) × 144 (W) × 49 (H) mm	220 (L) × 95 (W) × 45 (H) mm
Chiller	590 (L) × 484 (W) × 267 (H) mm	Not required

ENVIRONMENTAL & UTILITY REQUIREMENTS

Operating temperature	15 – 30 °C (59 – 86 °F)		17 – 27 °C (62 – 80 °F)	
Relative humidity	< 80 % (non condensing)			
Electric	110 – 220 VAC, 50 – 60 Hz			
Rated power	600 W	1000 W	300 W	
Power consumption	500 W	700 W	150 W	

¹⁾ Water-cooled version available on request.

²⁾ Lower repetition rates are available by controlling pulse picker.

³⁾ Precise wavelengths for specific models available upon request. 2nd (515 nm) and 3rd (343 nm) harmonic output also available.

⁴⁾ Under stable environmental conditions.

⁵⁾ Normalized to average pulse energy.

⁶⁾ Provides fast energy control; external analog control input available. Response time – next available RA pulse.

⁷⁾ Provides fast amplitude control of output pulse train.

⁸⁾ Custom spacing on request.

⁹⁾ Maximum number of pulses in a burst is dependent on the laser repetition rate. Custom number of pulses on request.

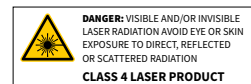

STABILITY MEASUREMENTS

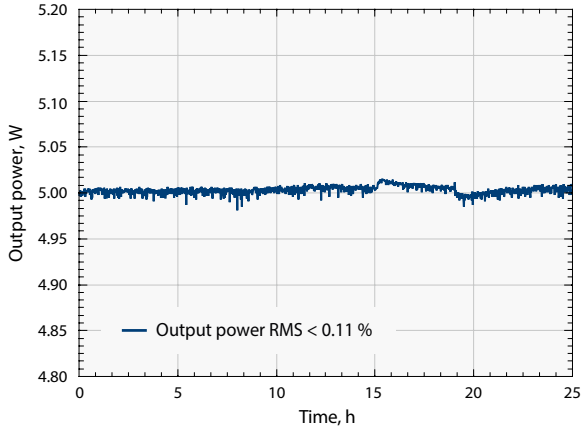

Output power under harsh environment conditions of CARBIDE-CB5

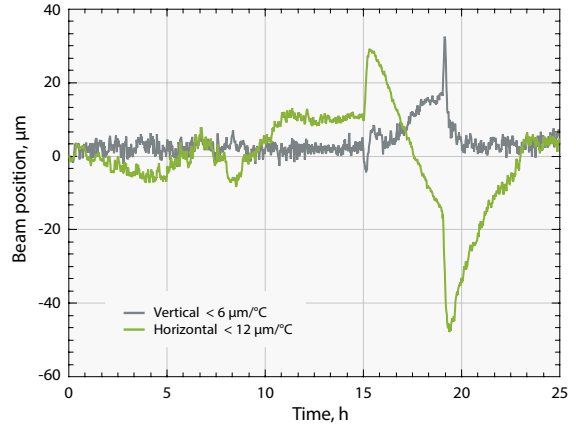

Beam position under harsh environment conditions of CARBIDE-CB5

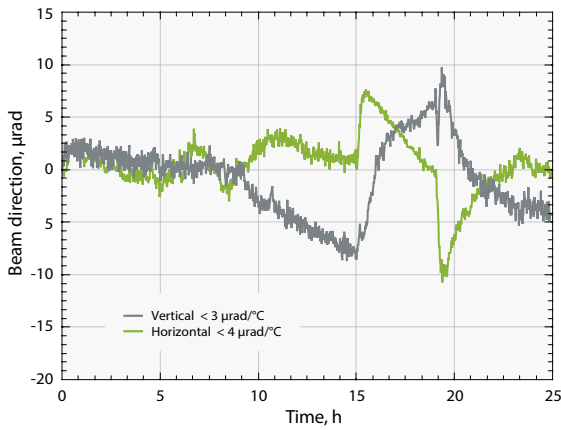

Beam direction under harsh environment conditions of CARBIDE-CB5

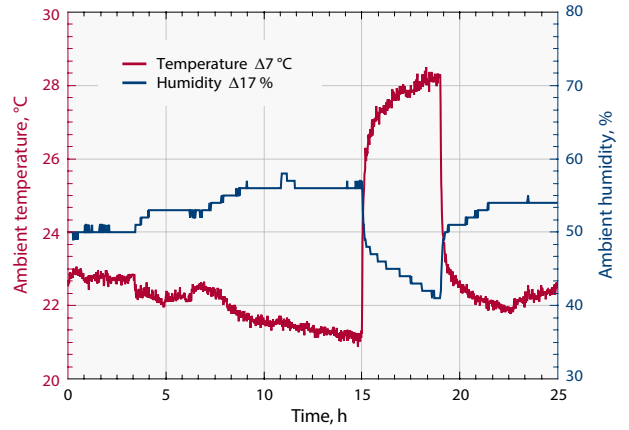

Harsh environment conditions of CARBIDE-CB5

OUTLINE DRAWINGS

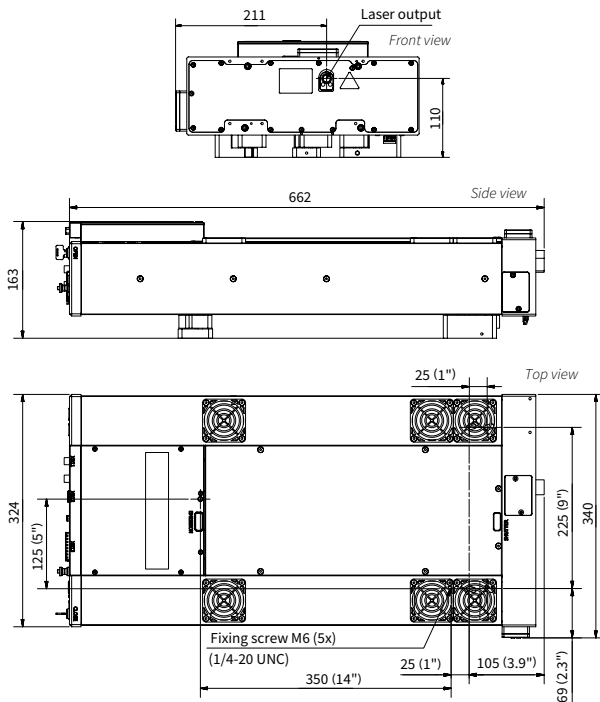

Outline drawing of air-cooled CARBIDE-CB5 with attenuator

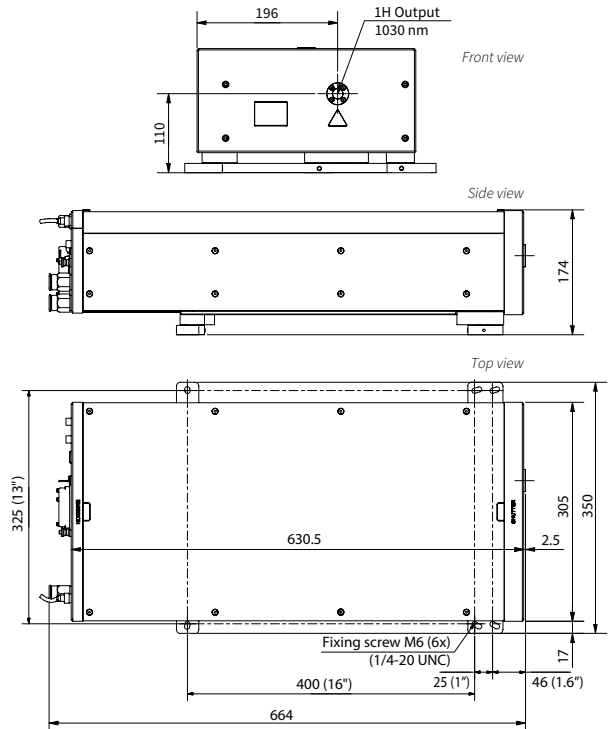

Outline drawing of CARBIDE-CB3

SCI-M | CARBIDE

Scientific Interface Module for CARBIDE

FEATURES

- Laser seeding via external OSC (FLINT)
- Uncompressed laser output access
- Provides simultaneous OSC output (~65 Mhz, <100 fs, >100 mW output power)
- Beam-splitting options



The CARBIDE scientific interface module is an optional laser add-on which extends the flexibility of industrial-grade laser configurations and makes it particularly attractive to scientific applications. This module incorporates multiple options which include a simultaneous or separate oscillator output, a second compressed or uncompressed main amplifier output and

seeding by an external oscillator. For example, it can be seeded by another CARBIDE laser with its own oscillator, thus ensuring precise optical synchronization between two lasers. All the mentioned amplifier outputs can be equipped with motorized power attenuators and all options are compatible in-between.

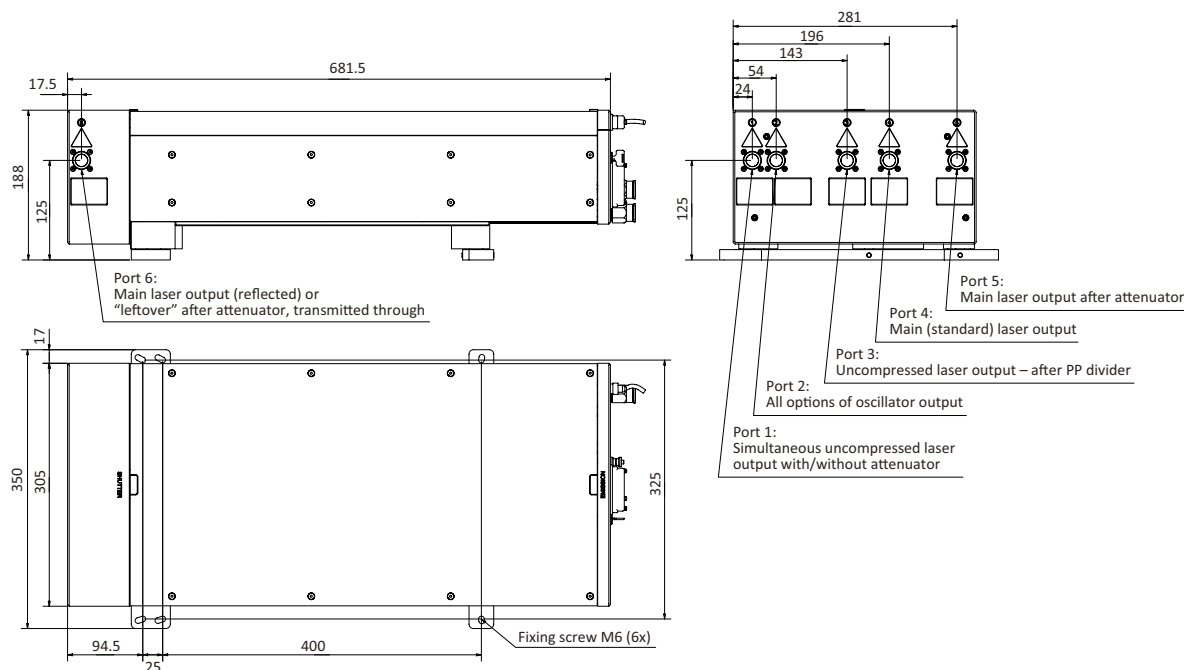

Outline drawing of CARBIDE-CB3-40-200 with scientific interface

HG | CARBIDE

Automated Harmonics Generators

FEATURES

- 515 nm, 343 nm and 257 nm
- Output selection by software
- Mounted directly on a laser head and integrated into the system
- Rugged, industrial-grade mechanical design



Harmonics generator module attached to air-cooled CARBIDE-CB5

CARBIDE laser can be equipped with automated harmonics modules. Selection of fundamental (1030 nm), second (515 nm), third (343 nm) or fourth (257 nm) harmonics outputs

are available by software control. Harmonics generators are designed to be used in industrial applications where a single output wavelength is desired.

SPECIFICATIONS

Model	2H	2H-3H	2H-4H
Output wavelength ¹⁾ (automated selection)	1030 nm 515 nm	1030 nm 515 nm 343 nm	1030 nm 515 nm 257 nm
Input pulse energy	20 – 800 μJ	50 – 800 μJ	20 – 800 μJ
Pump pulse duration	< 300 fs		
Conversion efficiency	> 50 % (2H)	> 50 % (2H) > 25 % (3H)	> 50 % (2H) > 10% (4H) ²⁾
Beam quality (M ²) ≤ 400 μJ pump	< 1.3 (2H), typical < 1.15	< 1.3 (2H), typical < 1.15 < 1.4 (3H), typical < 1.2	< 1.3 (2H), typical < 1.15 n/a (4H)
Beam quality (M ²) > 400 μJ pump	< 1.4 (2H)	< 1.4 (2H) < 1.5 (3H)	< 1.4 (2H) n/a (4H)

¹⁾ Depends on pump laser model.

²⁾ Maximum output power 1 W.

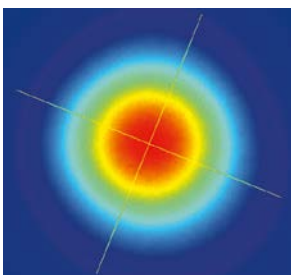
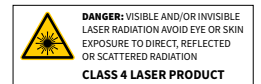

Typical 1H beam profile of CARBIDE-CB5, 60 kHz, 5 W

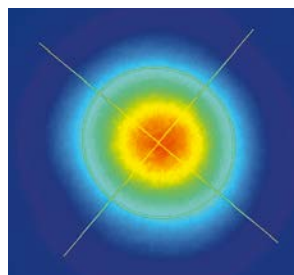

Typical 2H beam profile of CARBIDE-CB5, 100 kHz, 3.4 W

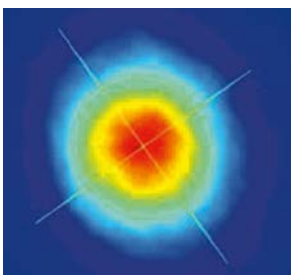

Typical 3H beam profile of CARBIDE-CB5, 100 kHz, 2.2 W

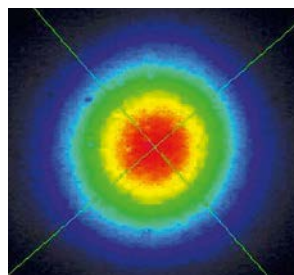

Typical 4H beam profile of CARBIDE-CB5, 100 kHz, 100 mW

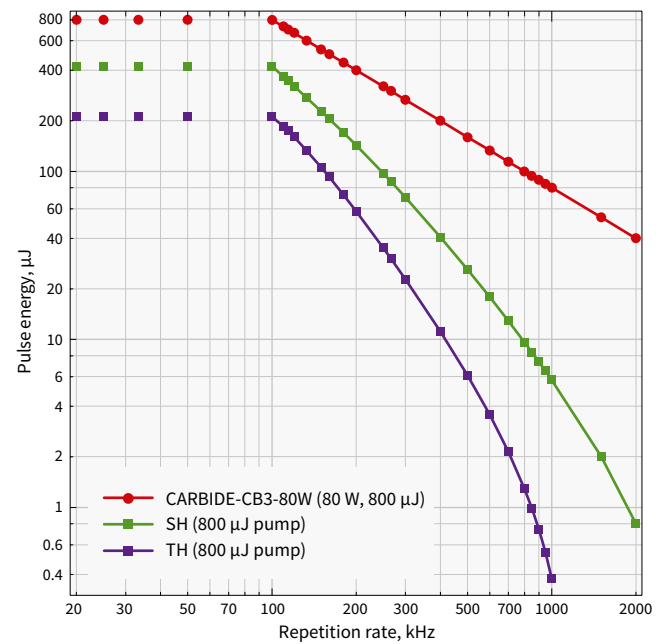

Harmonics energy vs pulse repetition rate for CARBIDE-CB3-80W

I-OPA

Industrial-grade Optical Parametric Amplifier

FEATURES

- Automatically tunable or fixed wavelength options
- Robust, integrated mechanical design
- Plug and play installation
- User friendly operation
- Up to 2 MHz repetition rate, down to single shot operation
- Up to 40 W pump power
- Short pulse duration option (< 100 fs)
- Integrated tunable beam splitter for pump laser beam



Tunable I-OPA-TW module attached to air-cooled CARBIDE-CB5

I-OPA series of optical parametric amplifiers marks a new era of simplicity in the world of tunable wavelength femtosecond light sources. Based on 10 years of experience producing the ORPHEUS series of optical parametric amplifiers, this solution brings together the flexibility of tunable wavelength with robust industrial-grade design. The original I-OPA is a rugged module attached to our PHAROS laser, providing long term stability comparable to that of the industrial harmonics modules. The new and improved tunable version is designed to be coupled with our PHAROS and CARBIDE series femtosecond lasers and primarily intended to be used with spectroscopy or microscopy applications that demand high stability. The -HP model is targeted to be coupled with our HARPIA series as a pump beam source for ultrafast pump-probe spectroscopy. The -F model is primarily designed to be used as a light source in multiphoton microscopy devices. The -ONE model will be useful in the field of mid-IR spectroscopy, as well as other applications where higher pulse energy is required in the infrared part of the spectrum. All of these models can be used for micromachining and other

industrial applications; the tunable version suited to be the ideal R&D system, while the fixed wavelength I-OPA would be the cost-effective solution for large scale production.

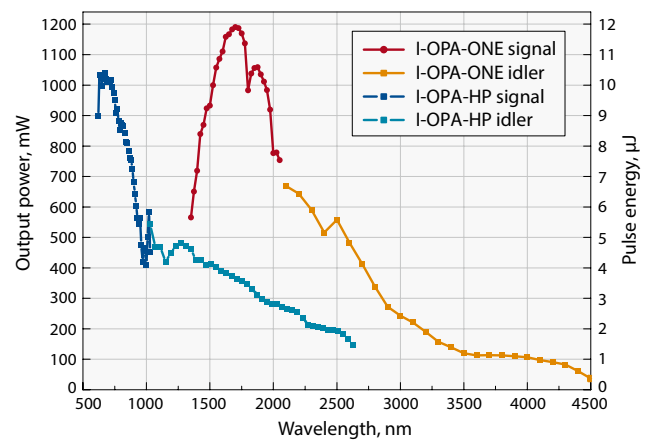

Typical I-OPA module energy conversion curves.
Pump: PHAROS-10W, 100 μJ, 100 kHz

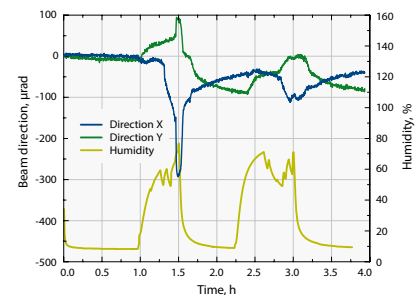
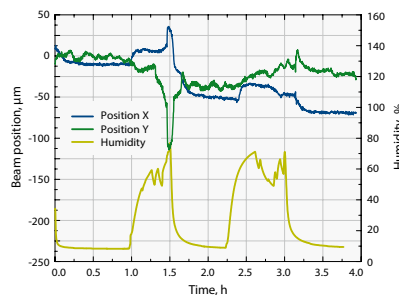
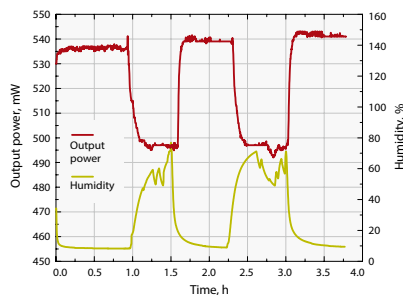

Fixed wavelength I-OPA-FW beam pointing and output power measurements under harsh environment conditions (humidity and temperature cycling)

SPECIFICATIONS OF TUNABLE I-OPA

Model	I-OPA-TW-HP	I-OPA-TW-F	I-OPA-TW-ONE
Based on ORPHEUS model	ORPHEUS	ORPHEUS-F	ORPHEUS-ONE
Pump power	Up to 40 W		
Pump pulse energy	10 – 400 μ J		20 – 400 μ J
Pulse repetition rate	Up to 2 MHz		
Tuning range, signal	640 – 1010 nm	650 – 900 nm	1350 – 2060 nm
Tuning range, idler	1050 – 2600 nm	1200 – 2500 nm	2060 – 4500 nm
Conversion efficiency at peak, signal wavelength	> 7 % @ 700 nm		> 9 % @ 1550 nm
Additional options	n/a	SCMP: Signal pulse compressor ICMP: Idler pulse compressor PCMP: pre-chirp dispersion compensator	n/a
Pulse bandwidth ¹⁾	80 – 220 cm^{-1} @ 700 – 960 nm	200 – 750 cm^{-1} @ 650 – 900 nm 150 – 500 cm^{-1} @ 1200 – 2000 nm	60 – 150 cm^{-1} @ 1450 – 2000 nm
Pulse duration ²⁾	120 – 250 fs	< 55 fs @ 800 – 900 nm < 70 fs @ 650 – 800 nm < 100 fs @ 1200 – 2000 nm	100 – 300 fs
Wavelength extension options	SHS: 320 – 505 nm SHI: 525 – 640 nm Conversion efficiency 1.2% at peak	Contact sales@lightcon.com	DFG: 4500 – 10000 nm ³⁾
Applications	Micro-machining Microscopy Spectroscopy	Nonlinear microscopy Ultrafast spectroscopy	Mid-IR spectroscopy AFM microscopy

¹⁾ I-OPA-F outputs broad bandwidth pulses which are compressed externally.

²⁾ Output pulse duration depends on wavelength and pump laser pulse duration.
I-OPA-F requires pulse compressors to achieve short pulse duration.

³⁾ Up to 16 μ m tuning range is accessible with external Difference Frequency Generator.

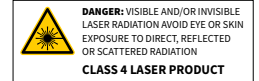

Fixed wavelength I-OPA in comparison to tunable version or standard ORPHEUS line devices lacks only computer-controlled wavelength selection. On the other hand, in-laser mounted design provides mechanical stability and eliminates the effects of air-turbulence ensuring stable long-term performance and minimizing energy fluctuations.



Fixed wavelength I-OPA-FW module attached to PHAROS

SPECIFICATIONS OF FIXED WAVELENGTH I-OPA

Model	I-OPA-FW-HP	I-OPA-FW-F	I-OPA-FW-ONE
Pump power		Up to 40 W	
Pump pulse energy	10 – 500 μ J	10 – 500 μ J	20 – 1000 μ J
Pulse repetition rate		Up to 2 MHz	
Wavelength range, signal	640 – 1010 nm	650 – 900 nm	1350 – 2060 nm
Wavelength range, idler	1050 – 2600 nm	1200 – 2500 nm	2060 – 4500 nm
Conversion efficiency at peak, signal wavelength	>7 % @ 700 nm	>7 % @ 700 nm	> 9 % @ 1550 nm
Pulse bandwidth ¹⁾	80 – 220 cm^{-1} @ 700 – 960 nm	200 – 750 cm^{-1} @ 650 – 900 nm 150 – 500 cm^{-1} @ 1200 – 2000 nm	60 – 150 cm^{-1} @ 1450 – 2000 nm
Pulse duration ²⁾	120 – 250 fs	< 55 fs @ 800 – 900 nm < 70 fs @ 650 – 800 nm < 100 fs @ 1200 – 2000 nm	150 – 300 fs
Applications	Micro-machining Microscopy Spectroscopy	Nonlinear microscopy Ultrafast spectroscopy	Micro-machining Mid-IR generation

¹⁾ I-OPA-F outputs broad bandwidth pulses which are compressed externally.

²⁾ Output pulse duration depends on wavelength and pump laser pulse duration. I-OPA-F requires external pulse compressors to achieve short pulse duration.

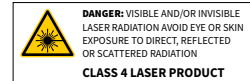

COMPARISON WITH OTHER FEMTOSECOND AND PICOSECOND LASERS

Laser technology	Our solution	HG or HIRO	I-OPA-FW-F	I-OPA-FW-ONE
Pulse energy at 100 kHz, using PHAROS-10W laser				
Excimer laser (193 nm, 213 nm)	5H of PHAROS (205 nm)	5 μ J	n/a	n/a
TH of Ti:Sa (266 nm)	4H of PHAROS (257 nm)	10 μ J		
TH of Nd:YAG (355 nm)	3H of PHAROS (343 nm)	25 μ J		
SH of Nd:YAG (532 nm)	2H of PHAROS (515 nm)	50 μ J	35 μ J	
Ti:Sapphire (800 nm)	OPA output (750 – 850 nm)	n/a	10 μ J	
Nd:YAG (1064 nm)	PHAROS output (1030 nm)		100 μ J	
Cr:Forsterite (1240 nm)	OPA output (1200 – 1300 nm)	n/a	5 μ J	n/a
Erbium (1560 nm)	OPA output (1500 – 1600 nm)		3 μ J	15 μ J
Thulium / Holmium (1.95 – 2.15 μ m)	OPA output (1900 – 2200 nm)		2 μ J	10 μ J
Other sources (2.5 – 4.0 μ m)	OPA output			1 – 5 μ J

Note that the pulse energy scales linearly in a broad range of pump parameters. For example, a PHAROS PH1-20 laser at 50 kHz (400 μ J energy) will increase the output power twice, and the pulse energy 4 times compared to the reference table above. The pulse duration at the output is <300 fs in all cases. The OPA output is not limited to these particular ranges of operation, it is continuously tunable as shown in energy conversion curves.

OUTLINE DRAWINGS

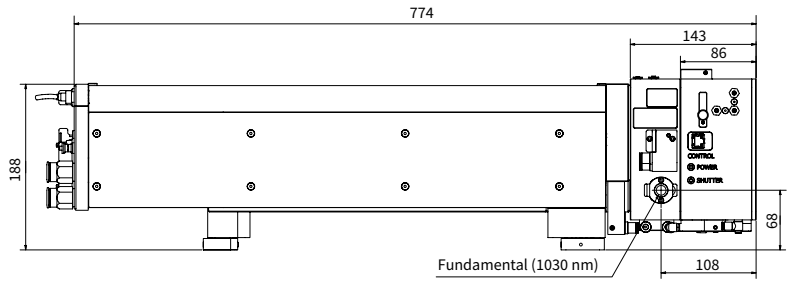
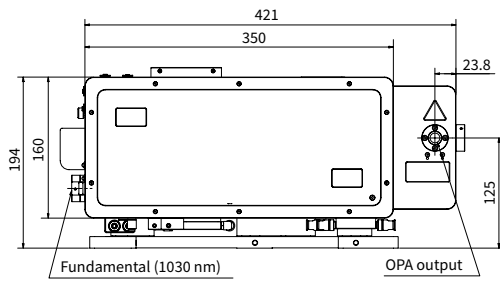

Outline drawing and output ports of CARBIDE-CB3 with tunable I-OPA-TW-HP

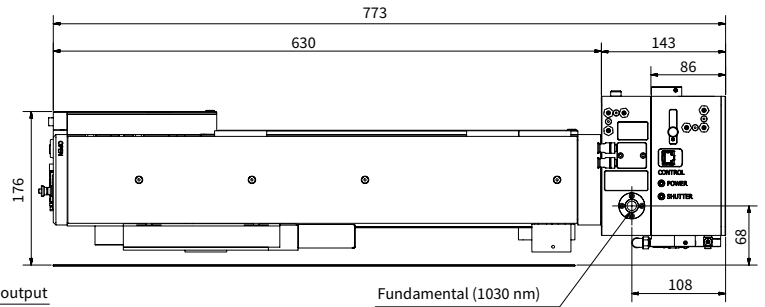
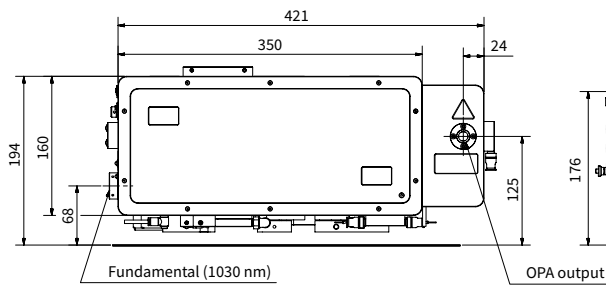

Outline drawing and output ports of CARBIDE-CB5 with tunable I-OPA-TW-HP

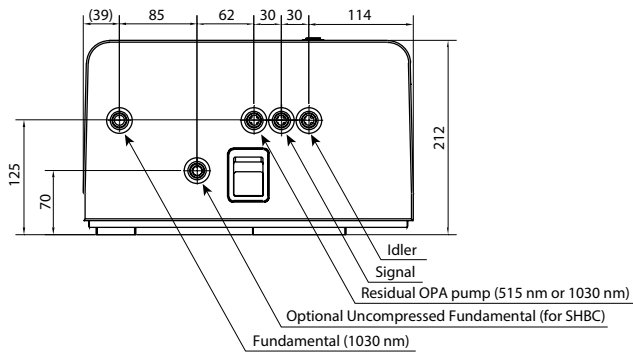

Output ports of PHAROS with fixed wavelength I-OPA-FW

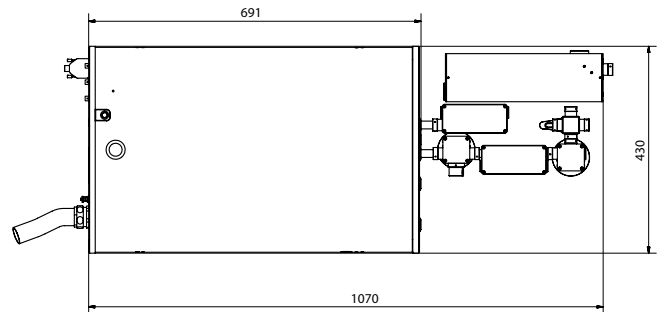

PHAROS with fixed wavelength I-OPA-FW-F and compressors for signal and idler

EXAMPLES OF INDUSTRIAL APPLICATIONS

Brittle & highly thermal sensitive material cutting

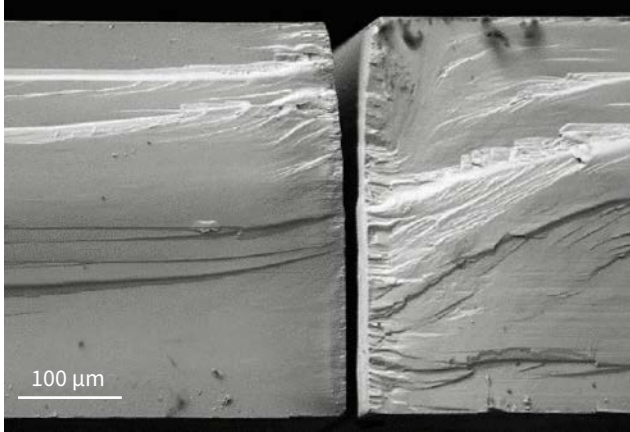

Multi-pass, cadmium tungstate cutting. No cracks. All thermal trace effects eliminated. Source: Micronanics Laser Solutions Centre.

Stainless steel stent cutting



Stent cut using CARBIDE laser. Source: Amada Miyachi America.

Glass needle microdrilling

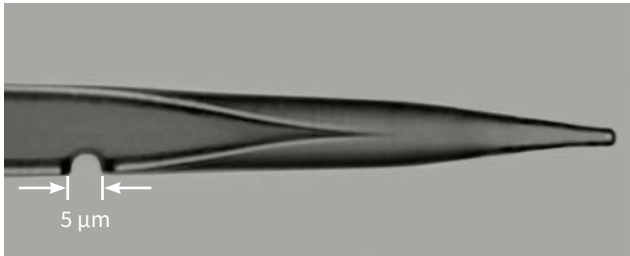

Glass needle microdrilling. Source: Workshop of Photonics.

Steel drilling

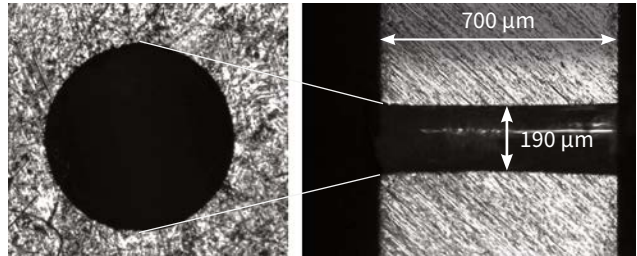

Taperless hole microdrilling in stainless steel alloys. Source: Workshop of Photonics.

Various type glass drilling

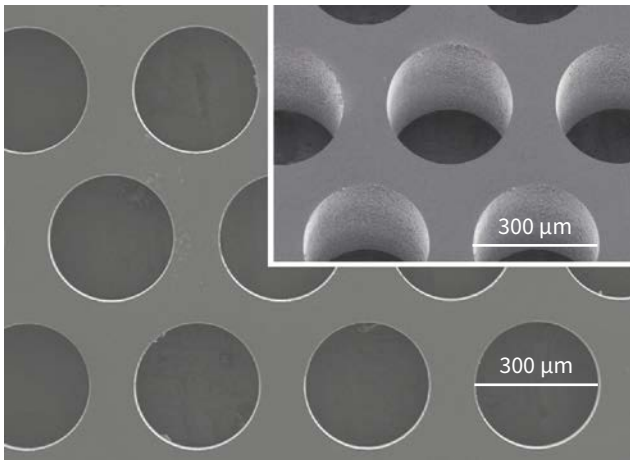

Various glass drilling. Source: Workshop of Photonics.

Nanodrilling in fused silica

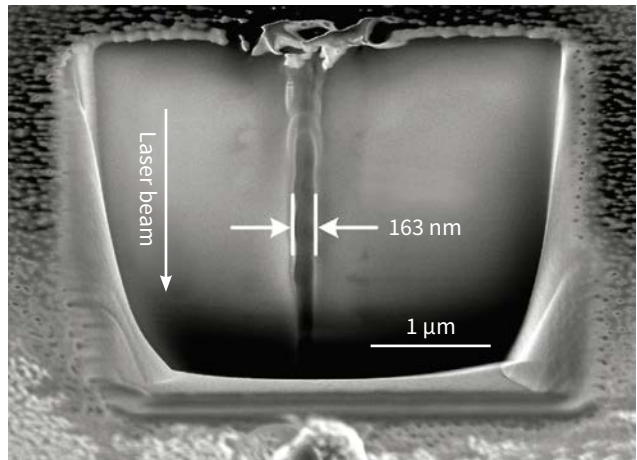

Longitudinal section of the single void. Source: "Ultrashort Bessel beam photoinscription of Bragg grating waveguides and their application as temperature sensors", G. Zhang, G. Cheng, M. Bhuyan, C. D'Amico, Y. Wang, R. Stoian. Photon. Res. (2019).

Milling of complex 3D surfaces



3D milled sample in copper. Zoom in SEM image.

Source: "Highly-efficient laser ablation of copper by bursts of ultrashort tuneable (fs-ps) pulses", A.Žemaitis, P.Gečys, M.Barkauskas, G.Račiukaitis, M.Gedvilas. Scientific Reports (2019).

Friction and wear reduction

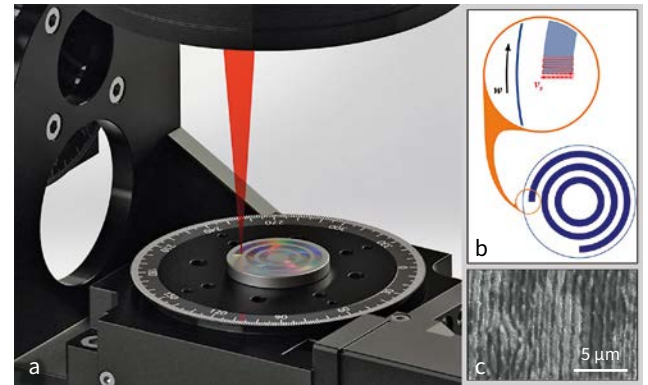

(a) Schematic of the laser treatment, (b) laser patterning strategy, (c) SEM image of induced LIPSS.

Source: "Tribological Properties of High-Speed Uniform Femtosecond Laser Patterning on Stainless Steel", I.Gnilitskiy, A.Rota, E.Gualtieri, S.Valeri, L.Orazi. Lubricants (2019).

Selective Cr thin film ablation

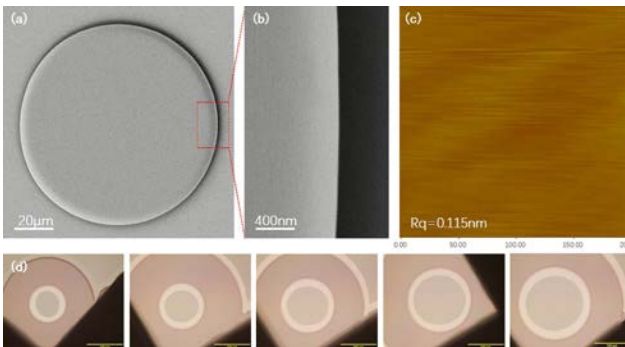

(a) SEM image of a fabricated LiNbO_3 micro-disk resonator, (b) close up view, (c) atomic force microscope (AFM) image of micro-disk wedge, (d) optical microscope image of micro-disk resonator with different diameters.

Source: "Fabrication of Crystalline Microresonators of High Quality Factors with a Controllable Wedge Angle on Lithium Niobate on Insulator", J.Zhang, Z.Fang, J.Lin, J.Zhou, M.Wang, R.Wu, R.Gao, Y.Cheng. Nanomaterials (2019).

3D waveguides

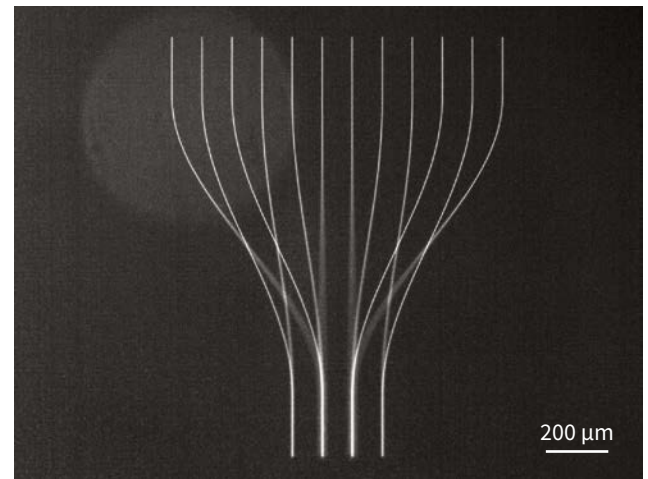

3D waveguide fabricated in fused silica glass.

Source: Workshop of Photonics.

Terahertz broadband anti-reflection structures

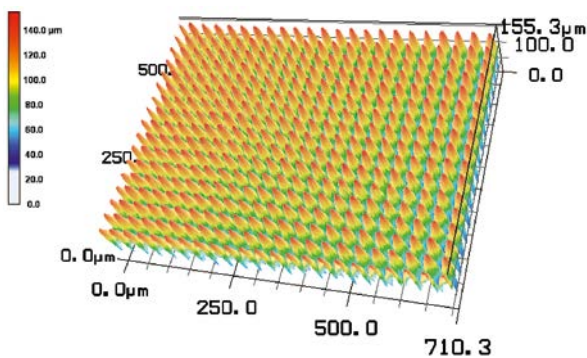

Fabricated moth-eye 3-D profile image, taken by laser scanning microscope.

Source: "Terahertz broadband anti-reflection moth-eye structures fabricated by femtosecond laser processing", H.Sakurai, N.Nemoto, K.Konishi, R.Takaku, Y.Sakurai, N.Katayama, T.Matsumura, J.Yumoto, M.Kuwata-Gonokami. OSA Continuum (2019).

Surface-enhanced Raman scattering (SERS) sensors fabrication

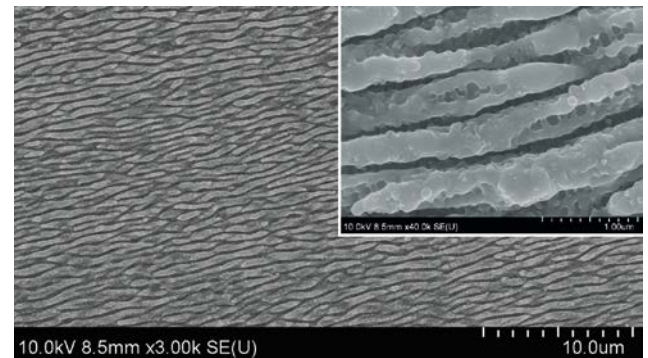

SEM image of the Ti-6Al-4V (TC4) surface after irradiation with progressively laser scan.

Source: "Large-Scale Fabrication of Nanostructure on Bio-Metallic Substrate for Surface Enhanced Raman and Fluorescence Scattering", L.Lu, J.Zhang, L.Jiao, Y.Guan. Nanomaterials (2019).

Lab-on-chip channel ablation and welding

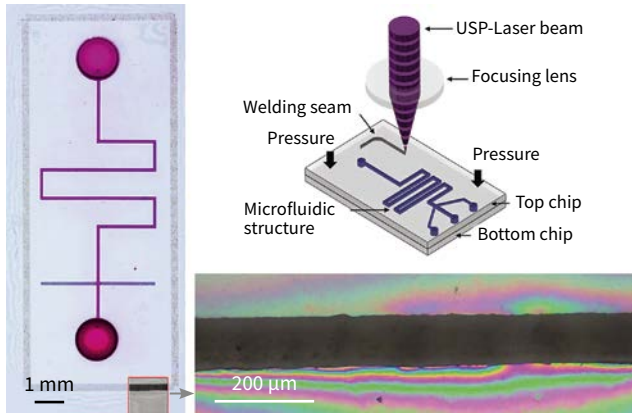

(a) Welding of transparent polymers for sealing of microfluidic devices, (b) COC welding seam (c) top view on a sealed microfluidic device.

Source: "A New Approach to Seal Polymer Microfluidic Devices Using Ultrashort Laser Pulses", G. Roth, C. Esen and R. Hellmann. JLMN-Journal of Laser Micro/Nanoengineering (2019).

3D micro printing using multi-photon polymerization

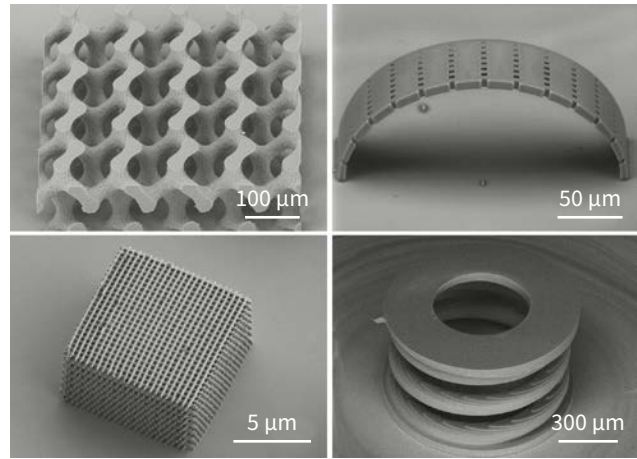

Various 3D structures fabricated in SZ2080 polymer using multi-photon polymerization – nanophotonic devices, microoptics, micromechanics.

Source: Femtika.

Bragg grating waveguide (BGW) writing

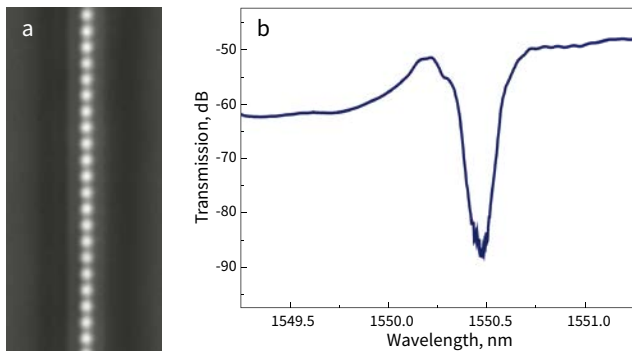

(a) first-order Bragg gratings inscribed in written waveguide, (b) Resonant spectral transmission of inscribed BGW.

Source: "Ultrashort Bessel beam photoinscription of Bragg grating waveguides and their application as temperature sensors", G.Zhang, G. heng, M.Bhuyan, C.D'Amico, Y.Wang, R.Stoian. Photon. Res. (2019).

3D glass etching

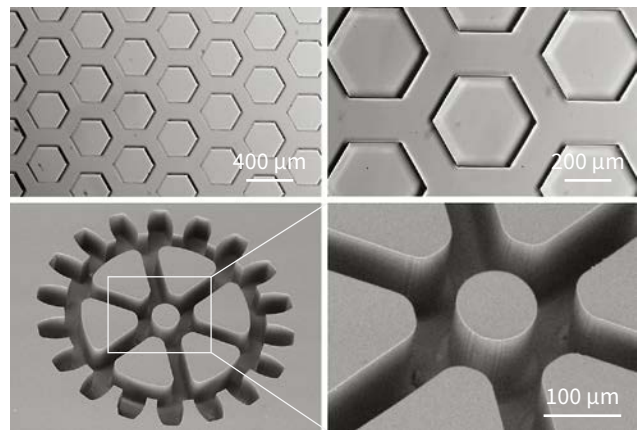

Various structures fabricated in fused silica glass.

Source: Femtika.

Birefringent glass volume modifications



Form induced birefringence-retardance variation results in different colors in parallel polarized light.

Source: Workshop of Photonics.

3D free shape multi-photon polymerization

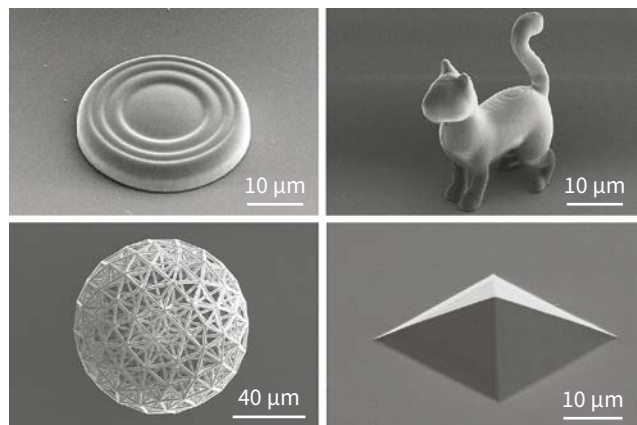

Various 3D structures fabricated in SZ2080 polymer using multi-photon polymerization.

Source: Workshop of Photonics.



Femtosecond Yb Oscillators

FEATURES

- Sub-40 fs without any additional pulse compressor
- 250 nJ pulse energy
- 20 W output power
- 76 MHz is standard
- No amplified spontaneous emission
- Rugged, industrial-grade mechanical design
- Automated second harmonic generator
- Optional CEP stabilization
- Possibility to lock to external clock



Typical view of FLINT-FL2

The FLINT oscillator is based on Yb crystal pumped by a high brightness laser diode module. Generation of femtosecond pulses is provided by Kerr lens mode-locking. Once started, mode-locking remains stable over a long period of time and

is immune to minor mechanical impact. Piezo-actuator can be implemented in customized oscillators in order to control the cavity length. FLINT oscillator can also be equipped with a Carrier Envelope Phase (CEP) stabilization system.

SPECIFICATIONS

Model	FL1-02	FL1-08	FL1-SP	FL2-12	FL2-20	FL2-SP
Max. average power	2 W	8 W	up to 2 W	> 12 W	> 20 W	up to 2 W
Pulse duration (assuming Gaussian pulse shape)	< 100 fs	< 120 fs	30 ... 50 fs ¹⁾	< 120 fs	< 170 fs	30 ... 50 fs ¹⁾
Max. pulse energy	> 25 nJ	> 100 nJ	up to 25 nJ	> 150 nJ	> 250 nJ	up to 25 nJ
Repetition rate	~ 76 MHz ²⁾		~ 76 MHz ³⁾	~ 76 MHz		~ 76 MHz ³⁾
Centre wavelength	1035 ⁴⁾ ± 10 nm	1030 ± 3 nm	1040 ± 10 nm	1029 ± 3 nm	1026 ± 2 nm	1040 ± 10 nm
Output pulse-to-pulse stability	< 0.5 % rms over 24 hours ⁵⁾					
Polarization	Linear, horizontal					
Beam quality	TEM ₀₀ ; M ² < 1.2					
Beam pointing stability	< 10 μrad/°C					
Optional 2H section	n/a			Yes, conversion efficiency > 30 %		
Internal attenuator	n/a			Yes		

PHYSICAL DIMENSIONS

Laser head	430 (L) × 195 (W) × 114 (H) mm	542 (L) × 322 (W) × 146 (H) mm
Power supply and chiller rack	642 (L) × 553 (W) × 540 (H) mm	642 (L) × 553 (W) × 673 (H) mm
Chiller	Included. Different options are available	

ENVIRONMENTAL & UTILITY REQUIREMENTS

Operating temperature	15–30 °C (air conditioning recommended)	
Relative humidity	< 80 % (non-condensing)	
Electric	110 V AC, 50–60 Hz, 2 A or 220 V AC, 50–60 Hz, 1 A	
Rated power	200 W	
Power consumption	100 W	150 W

¹⁾ Depends on output power ~600 mW <40 fs; up to 2 W <50 fs.

²⁾ Other repetition rates are available in the range from 60 to 100 MHz.

³⁾ Other repetition rates are available in the range from 70 to 80 MHz.

⁴⁾ Choice of a particular central wavelength with ±1 nm tolerance is available upon request.

⁵⁾ With enabled power-lock, under stable environment.

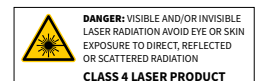

LOCKING OF THE OPTICAL PULSE TO AN EXTERNAL SIGNAL

PHAROS oscillator can be equipped with piezo actuators for precise control of the cavity length.

LONG TERM HARMONIC LOCK STABILITY TEST (40 hours)

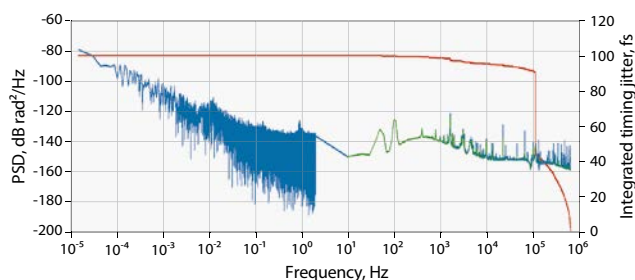

Laser oscillator (62.513 MHz) is locked to RF reference R&S SMB 100A (500.104 MHz). Measured integrated timing jitter* at 0.01 mHz – 600 kHz bandwidth is 110 fs

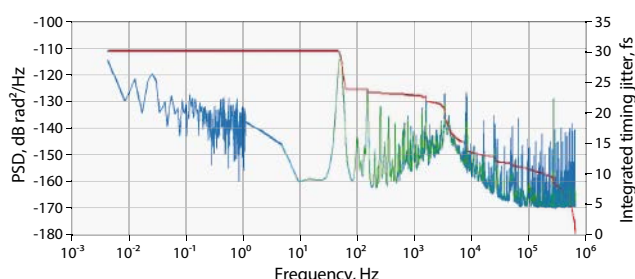

Laser oscillator (72.656 MHz) is locked to reference laser oscillator (72.656 MHz). Measured integrated timing jitter* at 0.01 Hz – 600 kHz band-width is 30 fs

* Integrated timing jitter up to 100 – 300 fs depending on RF source frequency, noise, environmental conditions, etc. For actual jitter specification please contact LIGHT CONVERSION.

CARRIER ENVELOPE PHASE (CEP) STABILIZATION

PHAROS oscillator can be equipped with nonlinear interferometer and feedback loop throughout the pump current of the laser diode bar for CEP stabilization.

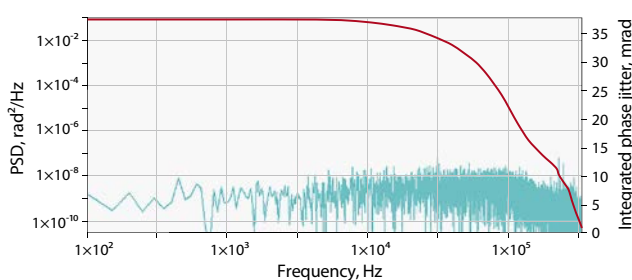

Single side power spectral density of f_{ceo} phase noise (in loop) and the integrated phase jitter.

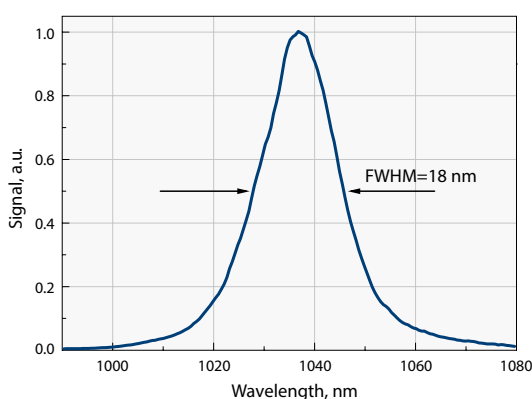

Typical FLINT optical spectrum

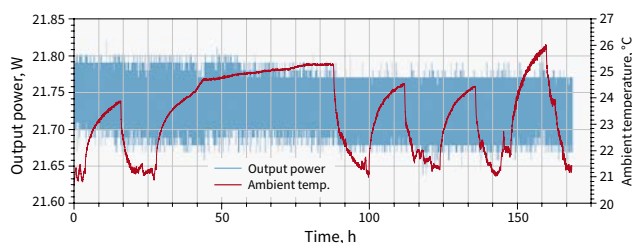

FLINT-FL2-20 (20 W) output power stability under harsh environmental conditions

OPTIONAL EQUIPMENT

Harmonics generator HIRO	see p. 24
--------------------------	-----------

OUTLINE DRAWINGS

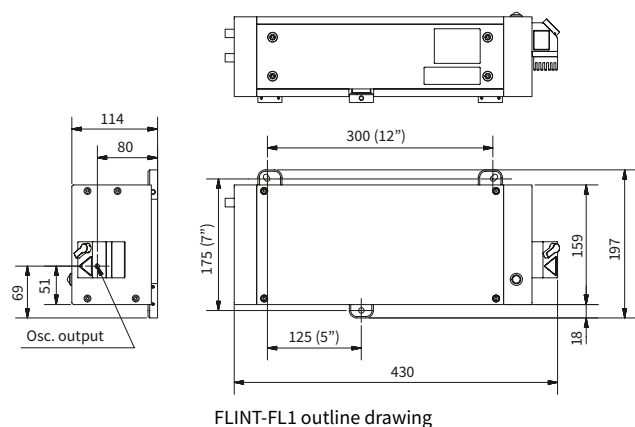

FLINT-FL1 outline drawing

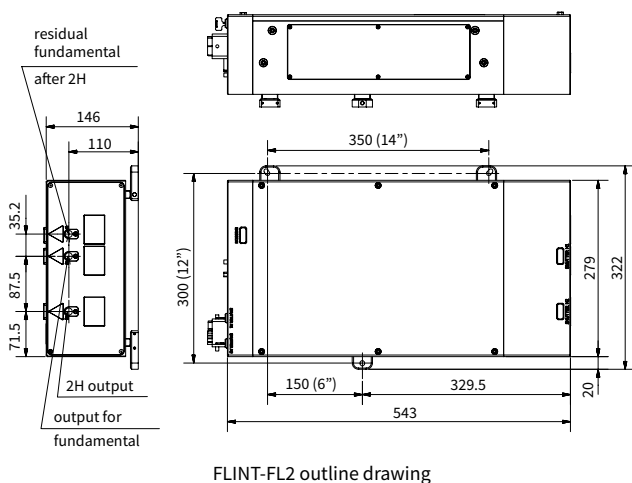

FLINT-FL2 outline drawing

HIRO

Harmonics Generator

FEATURES

- 515 nm, 343 nm, 257 nm
- Easy switching between active harmonic
- Simultaneous outputs available
- Integrated separation of the harmonics
- Flexible in fixing and easily customized to include additional options (continuum generators, beam expanders down-collimators)



HIRO is a valuable option for PHAROS/CARBIDE lasers and FLINT oscillators that provides high power harmonics radiation at 515 nm, 343 nm and 258 nm wavelengths. We offer several standard HIRO models (with open prospect of future upgrades) which meet most users' needs. The active harmonic is selected by manual rotation of the knob – changing the harmonics will never take longer than a few seconds thanks to its unique layout and housing construction.

HIRO is the most customizable and upgradable harmonics generator available on the market. It can be easily modified to provide white light continuum, beam splitting/expanding/down-collimating options integrated in the same housing, as well as harmonics splitting, that makes all three harmonics available at a time.

Please contact LIGHT CONVERSION for customized version of HIRO.

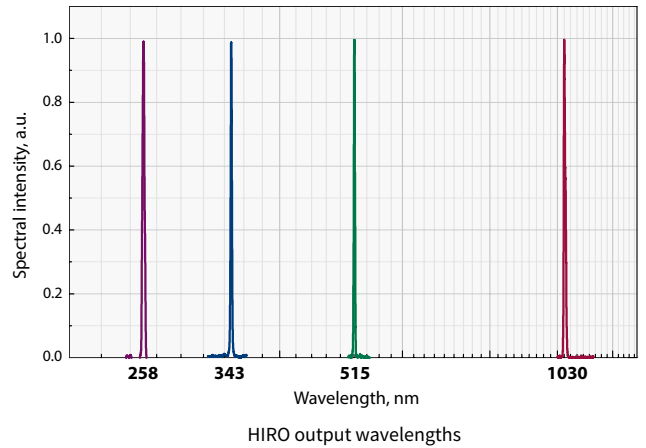

SPECIFICATIONS

Model	PH1F1	PH1F2	PH1F3	PH1F4	PH_W1	Output polarization
Available outputs ¹⁾	2H (515 nm)	2H (515 nm) 4H (258 nm)	2H (515 nm) 3H (343 nm)	2H (515 nm) 3H (343 nm) 4H (258 nm)	any combination and white light continuum	
Conversion efficiency of 2H ²⁾	> 50 %		> 50 % ³⁾			H (V ⁴⁾)
Conversion efficiency of 3H ²⁾	n/a		> 25 %			V (H ⁴⁾)
Conversion efficiency of 4H ²⁾	> 10 %		> 10 % ^{3) 5)}			V (H ⁴⁾)

PHYSICAL DIMENSIONS

General dimension of the housing	455 (L) × 160 (W) × 85 (H) mm
Recommended area for fixing	425 (L) × 255 (W) mm
Beam steering/intercepting	150 (L) × 55 (W) × 75 (H) mm

¹⁾ Depends on pump laser model.

²⁾ Harmonics conversion efficiencies are given as percentage of the input pump power/energy when the repetition rate is up to 200 kHz.

³⁾ When the third harmonic is not in use.

⁴⁾ Optional, depending on request.

⁵⁾ Max. 1 W.

Residual fundamental radiation available upon request.
HIRO pumped with ps pulses available on request.

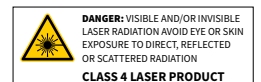

HARMONICS GENERATION FOR FLINT

FLINT oscillator can be equipped with optional wavelength converter HIRO providing harmonics radiation at 517 nm, 345 nm and 258 nm wavelengths.

Generated harmonics	2H	3H	4H
Output wavelength	517 nm	345 nm	258 nm
Conversion efficiency	>35 %	>5 %	>1 %

PHYSICAL DIMENSIONS

General dimension of the housing	455 (L) × 160 (W) × 85 (H) mm
Recommended area for fixing	425 (L) × 255 (W) mm
Beam steering/intercepting	150 (L) × 55 (W) × 75 (H) mm

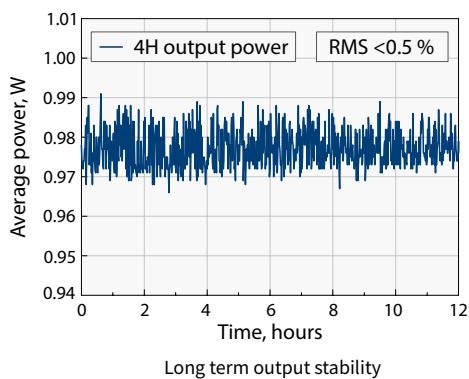
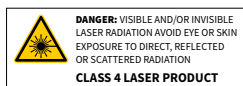

OUTLINE DRAWINGS

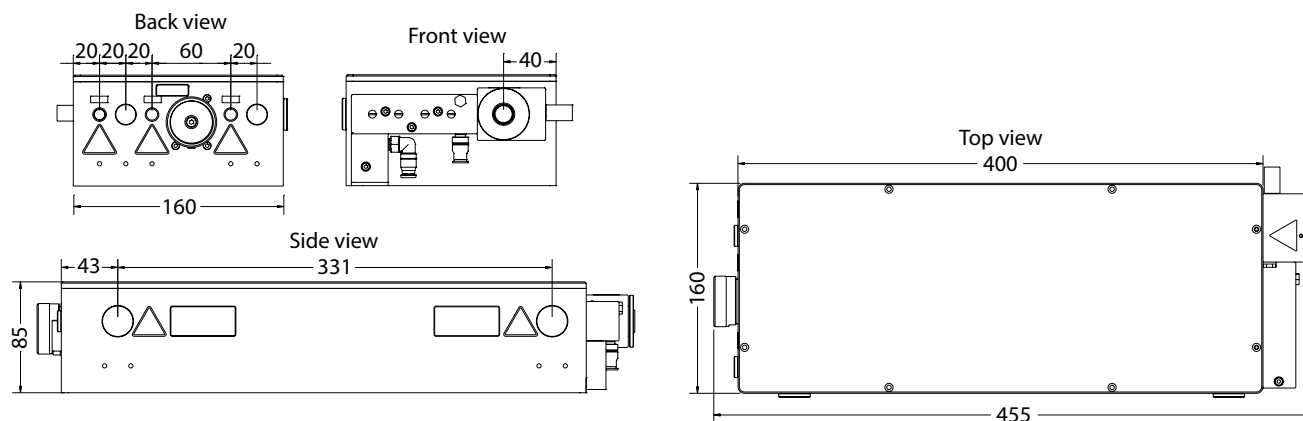

HIRO housing with water cooling system dimensions and positions of input/output ports (mm)

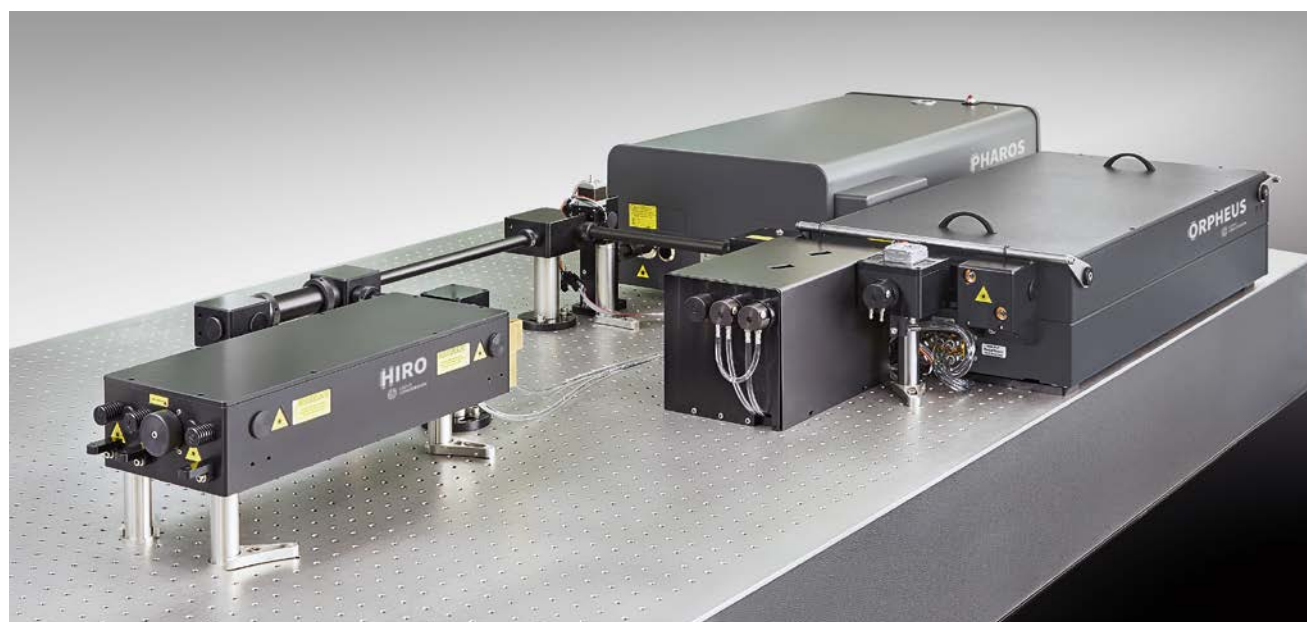

HIRO, PHAROS and ORPHEUS-HP in the lab



Second Harmonic Bandwidth Compressor

FEATURES

- High conversion efficiency to the narrow bandwidth second harmonic
- Small footprint



PHAROS / CARBIDE harmonic generator product line features second harmonic bandwidth compressor abbreviated as SHBC. The device is dedicated to the formation of narrow-bandwidth picosecond pulses from broadband output of an ultrafast laser. In the PHAROS / CARBIDE platform, SHBC is used to create flexible setups providing fixed wavelength or tunable narrow bandwidth ps pulses in combination with tunable wavelength broadband fs pulses. This feature is used in spectroscopy applications for mixing of wide and narrow bandwidth pulses such as sum-frequency spectroscopy (SFG). This setup allows efficient SH generation and so provides high pulse energies.

SPECIFICATIONS

Parameter	VALUE
Pump source	PHAROS / CARBIDE laser, 1030 nm, 70 – 120 cm ⁻¹ , 10 – 2000 μJ input pulse energy
Output wavelength ¹⁾	515 nm
Conversion ratio	> 30 %
Output pulse bandwidth	< 10 cm ⁻¹

¹⁾ Depends on pump laser model.

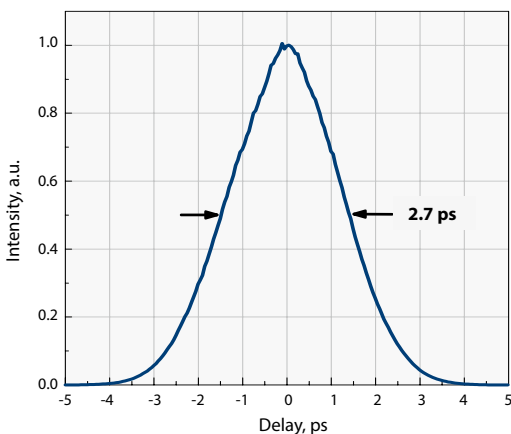
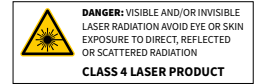

Typical pulse duration of SHBC output

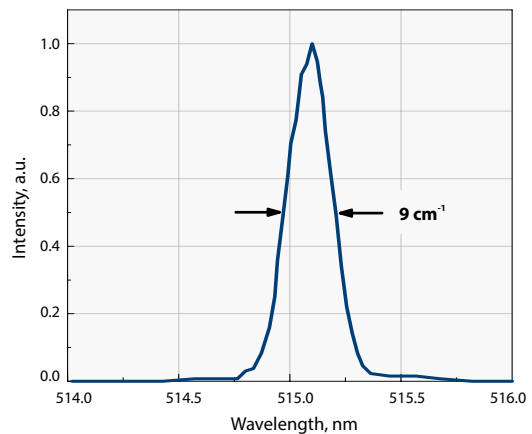

Typical spectrum of SHBC output

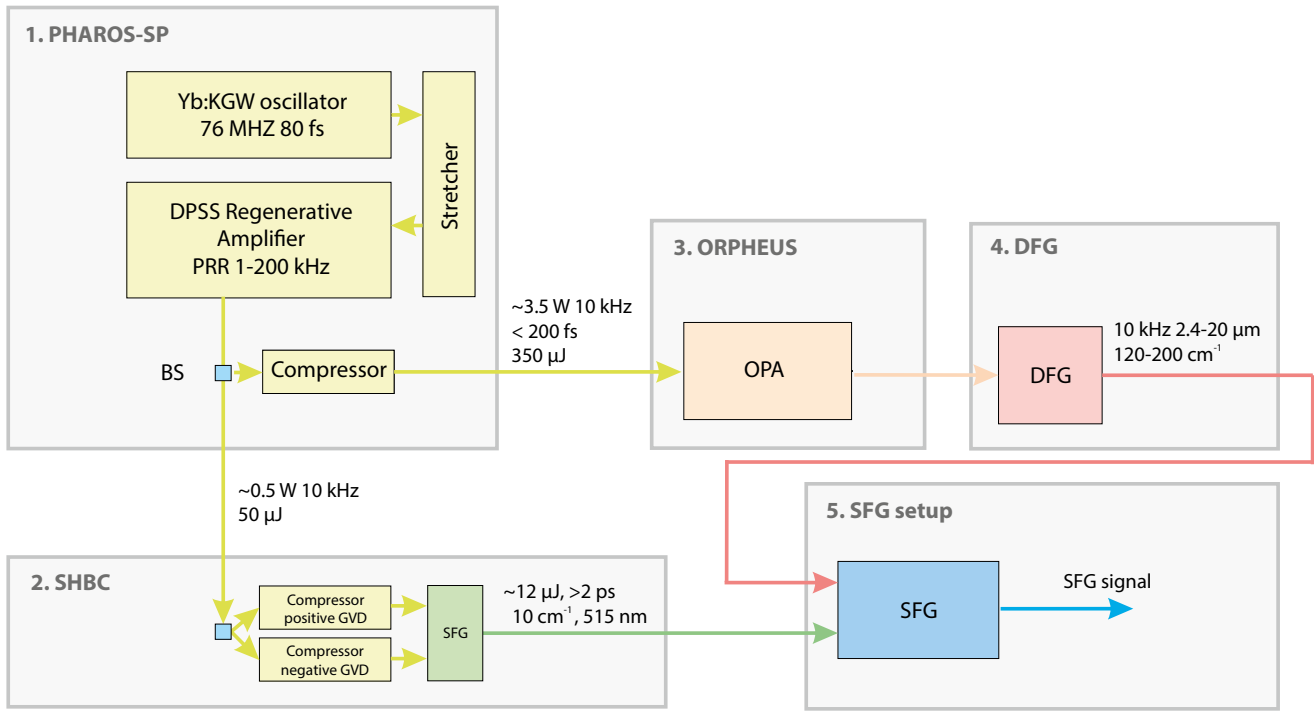

Principal layout of femtosecond sum-frequency generation (SFG) spectroscopy system using SHBC to produce one of the probe beams

OUTLINE DRAWINGS

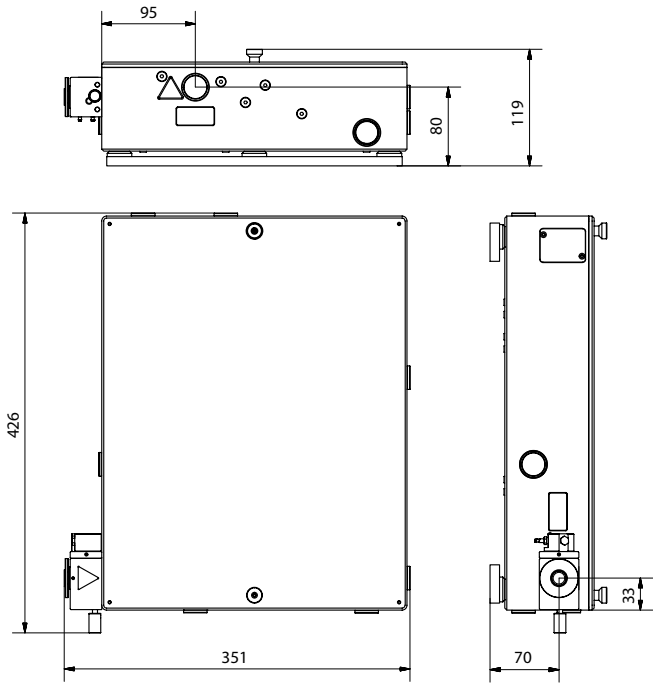

DIMENSIONS

	W × L × H
General dimension of the housing	351 × 426 × 119 mm
Recommended area for fixing	400 × 450 × 150 mm

ORPHEUS

Collinear Optical Parametric Amplifier

FEATURES

- 190 – 16000 nm tunable wavelength
- Single-pulse – 2 MHz repetition rate
- Up to 80 W pump power
- Up to 2 mJ pump energy
- Completely automated
- Integrated spectrometers for monitoring the output wavelength



ORPHEUS is collinear optical parametric amplifier of white-light continuum pumped by femtosecond Ytterbium based laser amplifiers. With the additional feature of being able to work at high repetition rates, ORPHEUS maintains the best properties of TOPAS series OPAs: high output pulse stability throughout the entire tuning range, high output beam quality and full computer control via USB port as well as optional frequency mixers to extend the tuning range from UV up to mid IR ranges. Femtosecond pulses and high power tunable output together with flexible multi kilohertz repetition rate make the tandem of ORPHEUS and PHAROS or CARBIDE lasers an invaluable tool for multiphoton microscopy, micro structuring and spectroscopy applications. Several ORPHEUS can be pumped by a single PHAROS or CARBIDE laser providing independent beam wavelength tuning.

ORPHEUS-HP and ORPHEUS-HE devices are modified versions of the ORPHEUS. ORPHEUS-HP is available with UV-VIS tuning range frequency mixers integrated into a thermally stabilized monolithic housing. Also, it provides the option of generating deep-ultraviolet pulses (190 – 215 nm) and DFG (2200 – 16000 nm). The design offers completely hands-free wavelength tuning and automated wavelength separation, ensuring the same position and direction for all wavelengths in UV, VIS and near IR regions. A mini spectrometer is integrated for online monitoring of output wavelength and comes with specialized software that enables wavelength feedback and automatic calibration. ORPHEUS-HE is available with UV-VIS tuning range extension and is dedicated for high energy pump lasers (1 – 2 mJ).

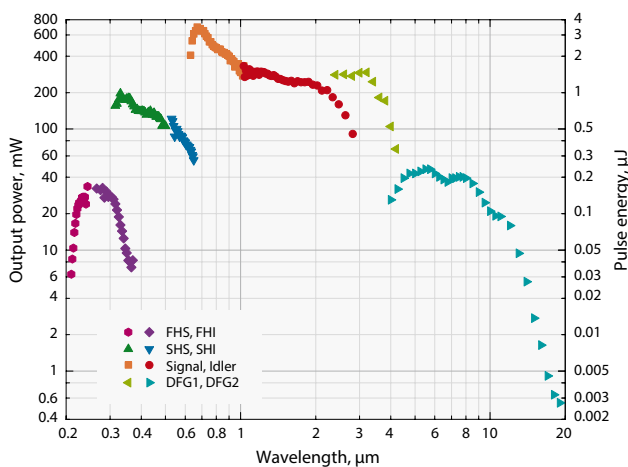

Typical tuning curve of **ORPHEUS**.
Pump: 6 W, 30 μJ, 200 kHz

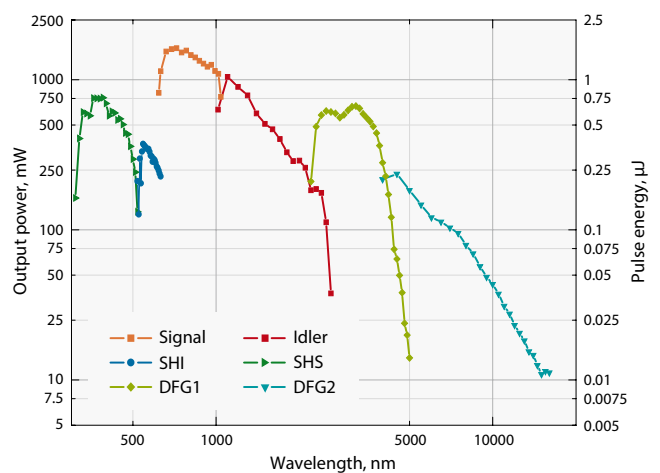

Typical tuning curve of **ORPHEUS-HP**.
Pump: 40 W, 40 μJ, 1000 kHz

For custom tuning curve value visit <http://toolbox.lightcon.com/tools/tuningcurves/>

SPECIFICATIONS

Model	ORPHEUS		ORPHEUS-HP		ORPHEUS-HE
OUTPUT FROM ORPHEUS					
Tuning range	630 – 1030 nm (Signal) 1030 – 2600 nm (Idler)				
Integrated second harmonic generation efficiency	> 35 % (515 nm) port B		not specified		
Pump power (max)	8 W		80 W		
Pump energy	8 – 20 μ J	20 – 400 μ J	8 – 20 μ J	20 – 400 μ J	400 – 2000 μ J ¹⁾
Conversion efficiency at peak	> 6 % (Signal + Idler combined)	> 12 % (Signal + Idler combined)	> 4.5 % (Signal) > 2 % (Idler)	> 9 % (Signal) > 4 % (Idler)	
Pulse duration	130 – 290 fs (PHAROS / CARBIDE) 120 – 190 fs (PHAROS-SP)				
Pulse bandwidth @ 700 – 960 nm	80 – 150 cm^{-1} (PHAROS / CARBIDE) 100 – 220 cm^{-1} (PHAROS-SP)				
Long term power stability (8 h)	< 2 % @ 800 nm				
Pulse energy stability (1 min)	< 2 % @ 800 nm				
Features	Cost effective		Completely automated		High energy & completely automated

WAVELENGTH EXTENSIONS

When pump energy	8 – 20 μ J	20 – 400 μ J	8 – 20 μ J	20 – 400 μ J	400 – 2000 μ J ¹⁾
SH package at peak (SH of Signal 315 – 515 nm; SH of Idler 515 – 630 nm)	> 1.2 %	> 3 %	> 1.2 %	> 2.4 %	
210 – 315 nm (TH of Signal)	n/a		> 0.4 % ²⁾	> 0.8 % ²⁾	
FH package at peak (FH of Signal 210 – 255 nm; FH of Idler 255 – 315 nm)	> 0.3 %	> 0.6 %	n/a		
190 – 215 nm (DeepUV)	—		> 0.3 % ³⁾	Contact sales@lightcon.com	
2200 – 4200 nm (DFG1)	> 1.5 % @ 3000 nm	> 3 % @ 3000 nm	> 1.5 % @ 3000 nm	> 3 % @ 3000 nm	
4000 – 16 000 nm (DFG2)	> 0.1 % @ 10000 nm	> 0.2 % @ 10000 nm	> 0.1 % @ 10000 nm	> 0.2 % @ 10000 nm	

¹⁾ Pump energy up to 5 mJ available, please contact sales@lightcon.com for specifications.

²⁾ Maximum output power 400 mW.

³⁾ DeepUV conversion efficiency is specified only when pump input to OPA is <10 W. In case of higher pump power, DeepUV efficiency decreases, the maximum output power is limited to ~40 mW @ 200 nm.

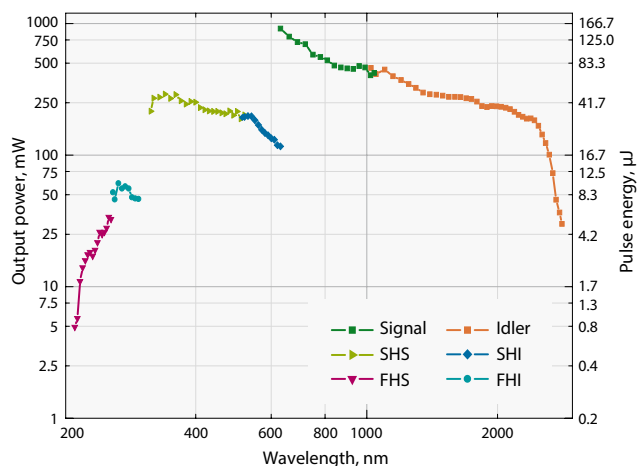
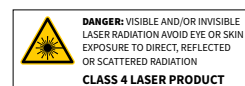

Typical tuning curve of **ORPHEUS-HE**.
Pump: 6 W, 1 mJ, 6 kHz

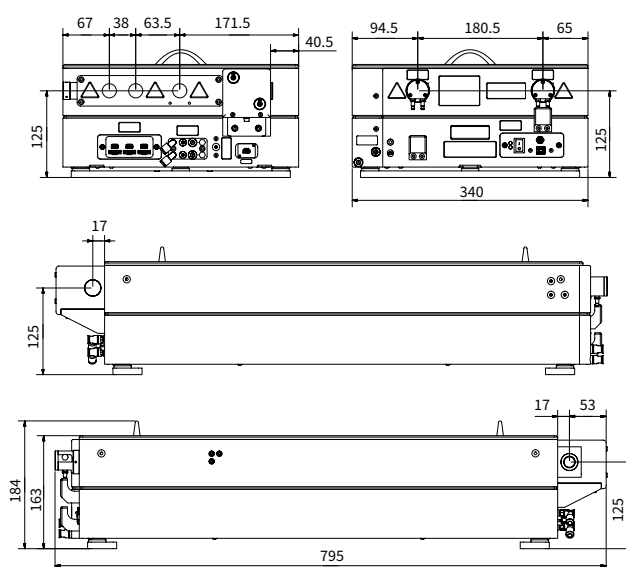

ORPHEUS outline drawings

ORPHEUS | ONE

Mid-IR Collinear Optical Parametric Amplifier

FEATURES

- Twice the output in mid-IR
- Broad-bandwidth >200 cm^{-1} configuration available
- 1350 – 16000 nm tunable wavelength
- Single-pulse – 2 MHz repetition rate
- Up to 80 W pump power
- Up to 2 mJ pump energy
- Computer-controlled



ORPHEUS-ONE is a collinear optical parametric amplifier (OPA) of white-light continuum pumped by femtosecond Ytterbium based laser amplifiers and focused on mid-infrared wavelengths generation.

In comparison to standard ORPHEUS + DFG configuration, the ORPHEUS-ONE provides higher conversion efficiency into the infrared range. The scheme used in ORPHEUS-ONE can generate >150 cm^{-1} bandwidth pulse when OPA is configured for broad-bandwidth amplification.

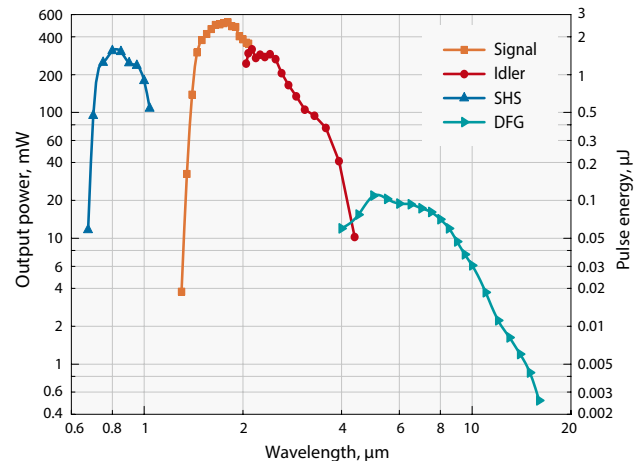

Typical tuning curve of **ORPHEUS-ONE**.
Pump: 6 W, 30 μJ , 200 kHz

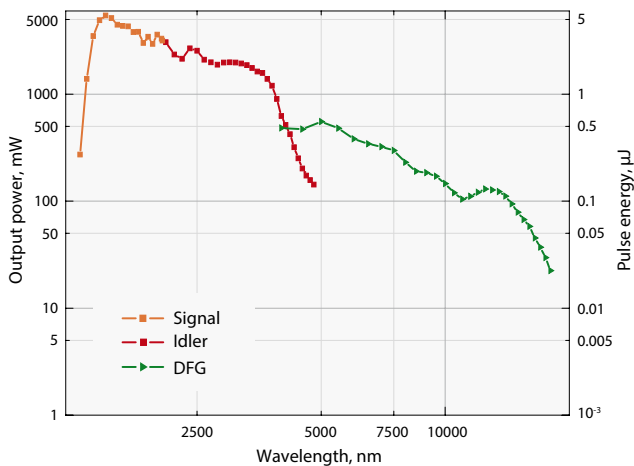

Typical tuning curve of **ORPHEUS-ONE-HP**.
Pump: 40 W, 40 μJ , 1000 kHz

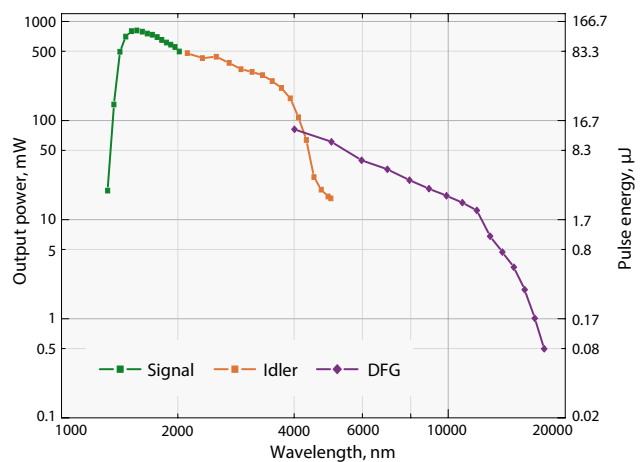

Typical tuning curve of **ORPHEUS-ONE-HE**.
Pump: 6 W, 1 mJ, 6 kHz

For custom tuning curve value visit <http://toolbox.lightcon.com/tools/tuningcurves/>

SPECIFICATIONS

Model	ORPHEUS-ONE	ORPHEUS-ONE-HP	ORPHEUS-ONE-HP (BB)	ORPHEUS-ONE-HE
-------	-------------	----------------	---------------------	----------------

OUTPUT FROM ORPHEUS-ONE (1350 – 4500 nm)

Tuning range	1350 – 2060 nm (Signal) 2060 – 4500 nm (Idler)		
Maximum pump power	8 W	80 W	
Pump energy	12 – 400 μ J	12 – 400 μ J	400 – 2000 μ J
Conversion efficiency at peak of tuning curve, signal and idler combined ¹⁾	> 14 %, pump 30 – 2000 μ J > 10 %, pump 12 – 30 μ J		
Pulse bandwidth	60 – 150 cm^{-1} @ 1450 – 2000 nm	> 300 cm^{-1} @ 1400 nm 60 – 140 cm^{-1} @ 1550 – 2000 nm	60 – 150 cm^{-1} @ 1450 – 2000 nm
Long term power stability (8 h)	< 2 % @ 1550 nm		
Pulse energy stability (1 min)	< 2 % @ 1550 nm		
Features	Cost-effective	High power	High energy

WAVELENGTH EXTENSIONS

Tuning range (SHS)	Contact sales@lightcon.com		
Tuning range (DFG2)	4500 – 16000 nm (based on signal and idler calibration)		
Pulse energy conversion efficiency ¹⁾	> 0.3 % @ 10000 nm, when pump energy 30 – 2000 μ J > 0.2 % @ 10000 nm, when pump energy 12 – 30 μ J		
Pulse bandwidth	60 – 150 cm^{-1} @ 5000 – 8000 nm	60 – 120 cm^{-1} @ 5000 – 8000 nm	

¹⁾ Conversion efficiency specified as the percentage of input power to ORPHEUS-ONE.

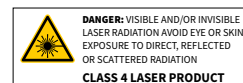

OUTLINE DRAWINGS

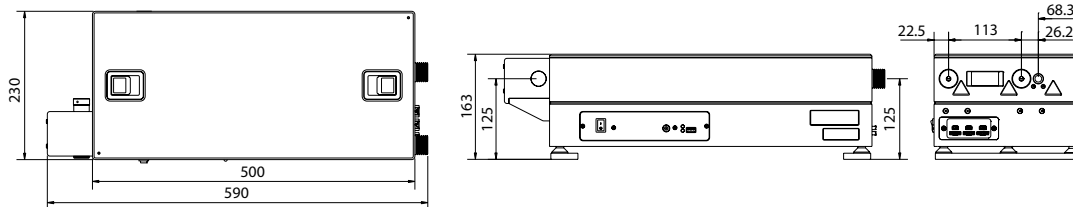

ORPHEUS-ONE outline drawings

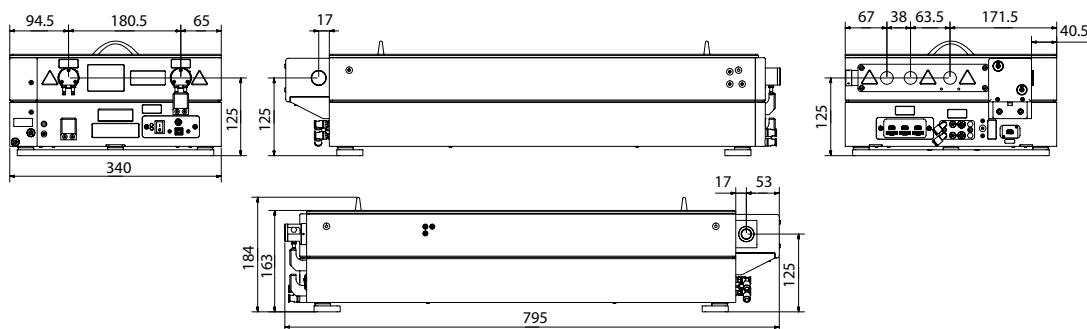

ORPHEUS-ONE-HP and ORPHEUS-HP outline drawings

ORPHEUS | F

Broad Bandwidth Hybrid Optical Parametric Amplifier

FEATURES

- Combines the best features of collinear and non-collinear OPA
- <100 fs pulse duration
- Variable bandwidth
- Single-pulse – 2 MHz repetition rate
- Computer-controlled
- Dual pulse width option provides gap-free tunability (650 – 2500 nm)



ORPHEUS-F is a hybrid optical parametric amplifier of white-light continuum pumped by femtosecond Ytterbium based laser amplifiers. This OPA combines the short pulse durations that are produced by a non-collinear OPA and wide wavelength tuning range (620 – 900 nm) offered by collinear OPA. The Signal beam can be easily compressed with a simple prism-based setup down to <60 fs in most of the tuning range, while Idler is compressed in bulk material down to 40 – 90 fs depending on wavelength. Switching to standard OPA configuration for tuning in 900 – 1200 nm range (250 fs)

is optional. It is possible to limit the output bandwidth to some extent (up to 2 – 3 times) without losing any output power. Standard ORPHEUS device uses spectral narrowing to produce bandwidth-limited 200 – 300 fs duration pulses directly at the output, with extended Signal/Idler tuning range and options to generate ultraviolet and mid-infrared light. Our non-collinear ORPHEUS-N-2H device produces even broader bandwidths, compressible down to <20 fs, but limits the tuning range to 650 – 900 nm. For most applications, the performance of ORPHEUS-F configuration is the optimal choice.

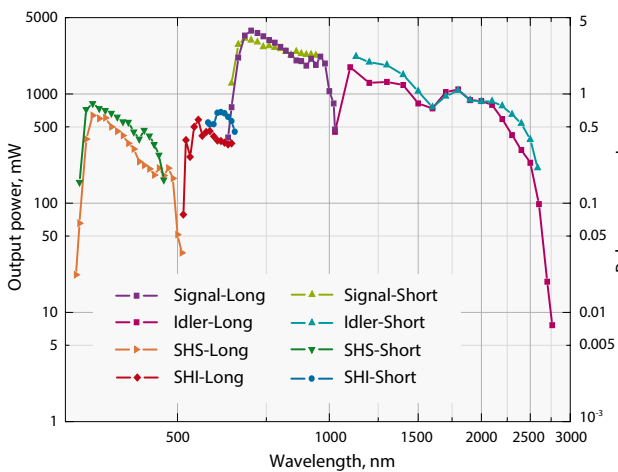

Typical energy conversion curve of **ORPHEUS-F**.
 Pump: 40 W, 40 µJ, 1000 kHz

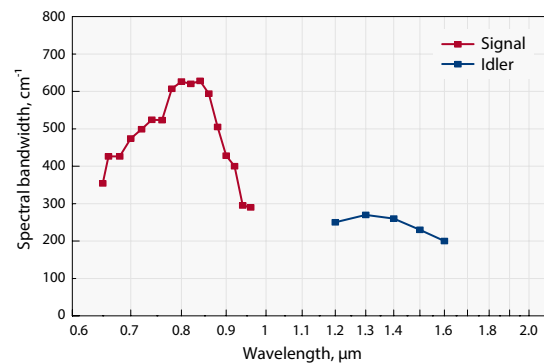

Typical spectral bandwidth of ORPHEUS-F

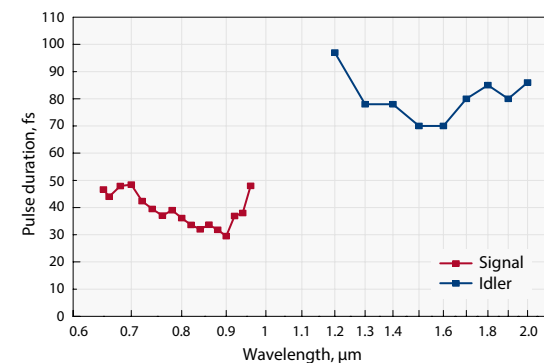

Pulse duration after compression of ORPHEUS-F

For custom tuning curve value visit
<http://toolbox.lightcon.com/tools/tuningcurves/>

SPECIFICATIONS

Model	ORPHEUS-F [short pulse mode]	ORPHEUS-F [long pulse mode]
-------	---------------------------------	--------------------------------

OUTPUT FROM ORPHEUS-F

Tuning range	Signal	650 – 900 nm	650 – 1010 nm
	Idler	1200 – 2500 nm	1050 – 2500 nm
Integrated second harmonic generation efficiency		> 35 % (515 nm) ¹⁾	
Pump power (maximum)		Up to 80 W	
Pump energy		10 – 500 μJ	
Conversion efficiency at peak, Signal + Idler combined		> 10 %	
Pulse duration before compression		< 290 fs	
Pulse bandwidth	650 – 900 nm	200 – 750 cm ⁻¹	80 – 150 cm ⁻¹ (PHAROS / CARBIDE) 100 – 220 cm ⁻¹ (PHAROS-SP)
	800 – 900 nm	< 55 fs	n/a
Pulse duration after compressor	650 – 800 nm	< 70 fs	
	1200 – 2000 nm	< 100 fs	
	Typical: 650 – 900 nm	25 – 70 fs	
	Typical: 1200 – 2000 nm	40 – 100 fs	
Compressor transmission	650 – 900 nm	> 65 %	
	1200 – 2000 nm	> 80 %	
Long term power stability (8 h)		< 2 % @ 800 nm	
Pulse energy stability (1 min)		< 2 % @ 800 nm	

WAVELENGTH EXTENSIONS

At peak	325 – 450 nm (SH of Signal)	> 1 %	n/a
	325 – 505 nm (SH of Signal)	n/a	> 1 %
	525 – 650 nm (SH of Idler)		> 0.5 %
	600 – 700 nm (SH of Idler)	> 0.5 %	n/a
	210 – 252 nm (FH of Signal)	n/a	> 0.1 %
	263 – 325 nm (FH of Idler)		> 0.2 %
	2200 – 4200 nm (DFG1)	Contact sales@lightcon.com	
	4000 – 16000 nm (DFG2)		

¹⁾ At designated output port.

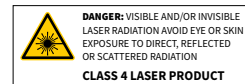

OUTLINE DRAWINGS

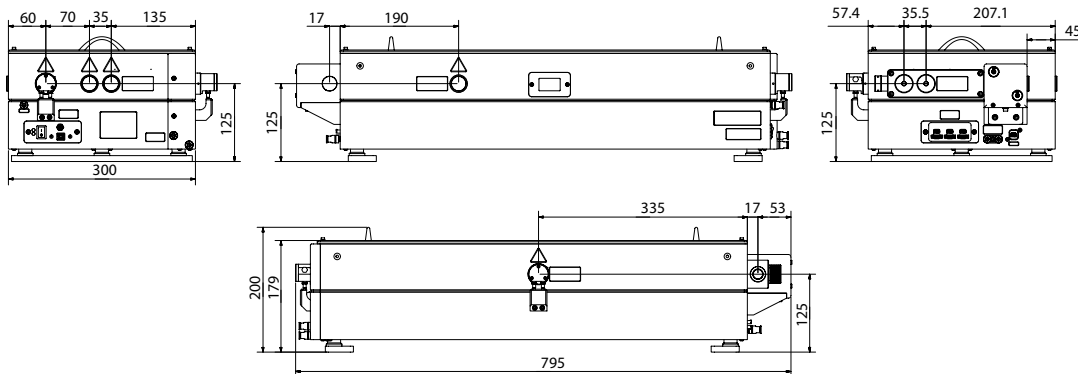

ORPHEUS-F outline drawings

ORPHEUS | N

Non-Collinear Optical Parametric Amplifier

FEATURES

- < 30 fs pulse duration
- Integrated prism compressor
- Adjustable bandwidth and pulse duration
- Single-pulse – 1 MHz repetition rate
- Computer-controlled



ORPHEUS-N is a non-collinear optical parametric amplifier (NOPA) pumped by a Ytterbium-based femtosecond laser amplifier. Depending on the ORPHEUS-N model, it has a built-in second or third harmonic generator producing 515 nm or 343 nm pump. ORPHEUS-N with second harmonic pump (ORPHEUS-N-2H) delivers pulses of less than 30 fs in the 700 – 850 nm range with average power of more than 0.5 W at 700 nm¹⁾. ORPHEUS-N with third harmonic pump (ORPHEUS-N-3H) delivers pulses of less than 30 fs in the 530 – 670 nm range with average power of more than 0.2 W at 550 nm. ORPHEUS-N works at repetition rates of up to 1 MHz.

The device is equipped with computer-controlled stepping motor stages, allowing automatic tuning of the output wavelength. An optional signal's second harmonic generator is also available, extending the tuning range down to 250 – 450 nm. Featuring a state of the art built-in pulse compressor ORPHEUS-N is an invaluable instrument for time-resolved spectroscopy. More than one ORPHEUS-N systems can be operated simultaneously with a single amplifier providing several pump and/or probe channels with independent wavelength tuning.

¹⁾ When pumped with 6 W @ 1030 nm, 200 kHz.

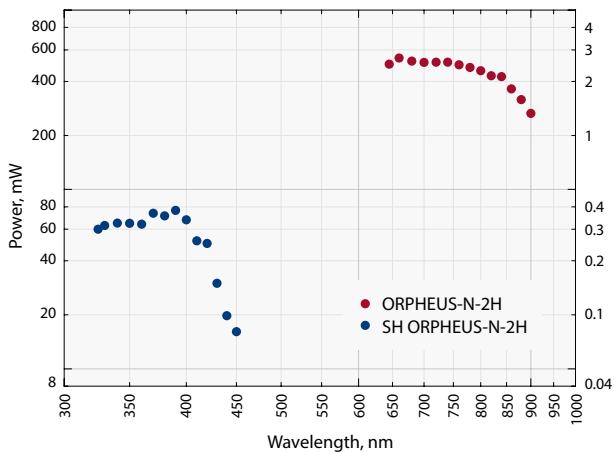

Typical tuning curve of **ORPHEUS-N-2H**
Pump: 6 W, 30 µJ, 200 kHz

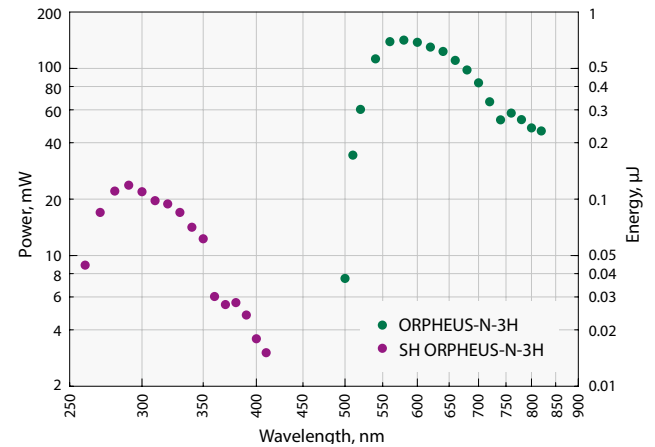

Typical tuning curve of **ORPHEUS-N-3H**
Pump: 6 W, 30 µJ, 200 kHz

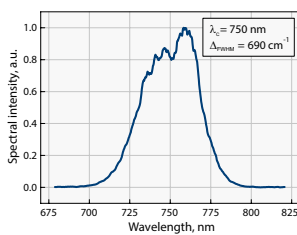

Typical output of **ORPHEUS-N-2H**

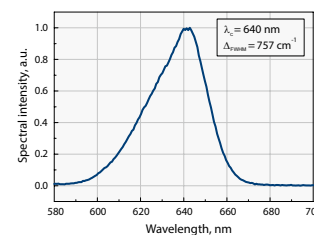
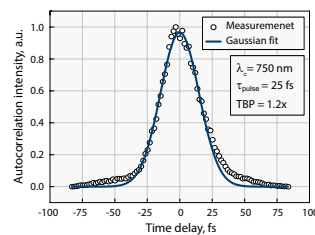

Typical output of **ORPHEUS-N-3H**

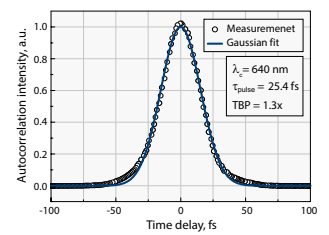

For custom tuning curve value visit <http://toolbox.lightcon.com/tools/tuningcurves/>

SPECIFICATIONS

Model	ORPHEUS-N-2H	ORPHEUS-N-3H			
OUTPUT FROM ORPHEUS-N					
Tuning range	650 – 900 nm (Signal)	520 – 900 nm (Signal)			
Integrated second (third) harmonic generation efficiency	> 35 % (515 nm)	> 25 % (343 nm)			
Pump power (maximum)	8 W				
Pump pulse energy	10 – 200 μ J	12 – 200 μ J			
Conversion efficiency at peak	700 nm	800 nm	580 nm	700 nm	800 nm
	> 7 %	> 5 %	> 1.3 %	> 0.7 %	> 0.3 %
Pulse duration after compressor	< 30 fs (700 – 850 nm)	< 30 fs (530 – 670 nm) < 80 fs (670 – 900 nm)			
Long term power stability (8 h)	< 2 % @ 800 nm	< 2 % @ 580 nm			
Pulse energy stability (1 min)	< 2 % @ 800 nm	< 2 % @ 580 nm			
WAVELENGTH EXTENSIONS					
Tuning range (SH of Signal)	325 – 450 nm	260 – 450 nm			
Conversion efficiency at peak	> 10 % of Signal				

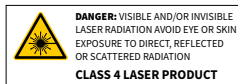

OUTLINE DRAWINGS

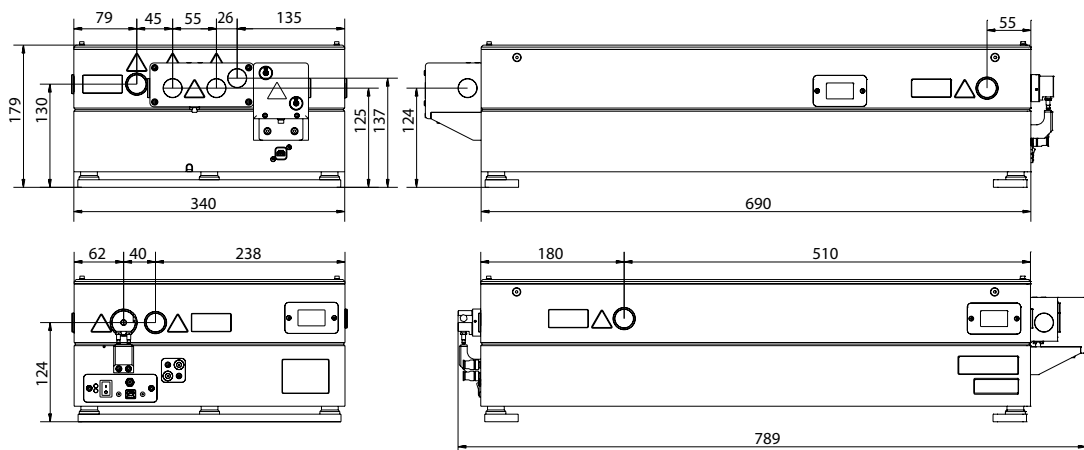

ORPHEUS-N outline drawings



ORPHEUS-N setup example

ORPHEUS | TWINS

Two Independently Tunable Optical Parametric Amplifiers

FEATURES

- Two OPA units in a single compact housing
- 210 nm – 16 μm tunable wavelength
- Single-pulse – 2 MHz repetition rate
- Standard pump energy up to 0.5 mJ (2 mJ upon request)
- Broadband and short-pulse (<100 fs) versions available
- CEP stable mid-infrared output available
- Integrated spectrometers for monitoring OPA output wavelength



ORPHEUS-TWINS consists of two independently tunable optical parametric amplifiers designed for flexible pump parameters and OPA configuration. The two channels can be separately configured to be a version of either ORPHEUS, ORPHEUS-ONE, ORPHEUS-F or even ORPHEUS-N. Both OPA units are integrated into a single housing and share the same

white light seed for amplification. The design of this OPA enables hands-free wavelength tuning, optional automated wavelength separation and the possibility of generating broadband mid-infrared radiation, in the region of 4 – 16 μm, with a passively stable Carrier Envelope Phase (CEP).

SPECIFICATIONS

Model	ORPHEUS-TWINS
Required pump laser	PHAROS or CARBIDE
Accepted pump input pulse energy @ 1030 nm, 180 – 300 fs pulse duration	16 – 500 μJ (up to 2 mJ upon requests)
Supported repetition rates	Single-pulse – 2 MHz
Tuning range	Choice between ORPHEUS, ORPHEUS-F, ORPHEUS-N-2H or ORPHEUS-ONE configurations
Output pulse energy	Depends on the configuration – check the specifications of the chosen models
Pulse bandwidth	Depends on configuration, up to 100 – 750 cm ⁻¹
Pulse duration	Depends on configuration, down to 40 fs

PHYSICAL DIMENSIONS

Full dimension of the ORPHEUS-TWINS, including wavelength separation (W × L × H)	810 × 430 × 164 mm
Full dimensions of the PHAROS+ORPHEUS-TWINS system with beam routing units (W × L × H)	910 × 850 × 215 mm

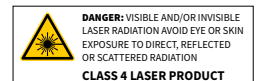

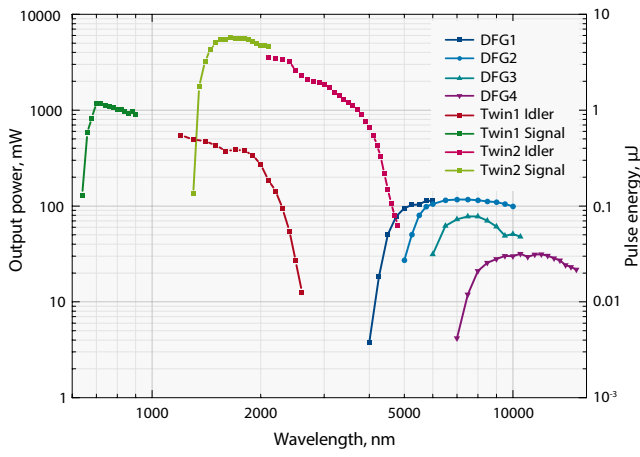

ORPHEUS-TWINS (ONE/F configuration)
 output power conversion curve.
 Pump: 40 W, 40 μJ, 1000 kHz

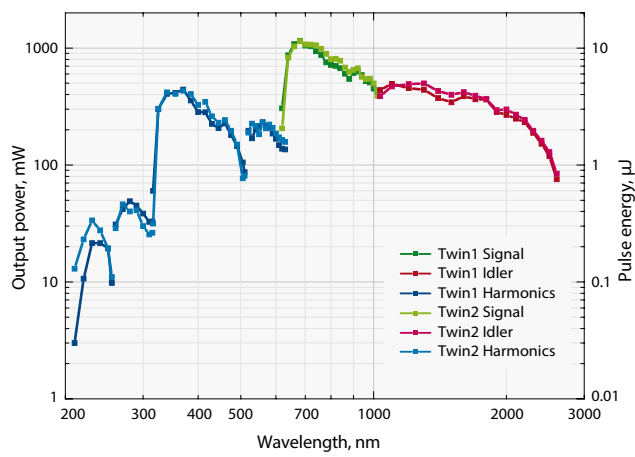

ORPHEUS-TWINS (ORPHEUS/ORPHEUS configuration)
 output power conversion curve.
 Pump: 20 W, 20 μJ, 100 kHz

For custom tuning curve value visit <http://toolbox.lightcon.com/tools/tuningcurves/>

OUTLINE DRAWINGS

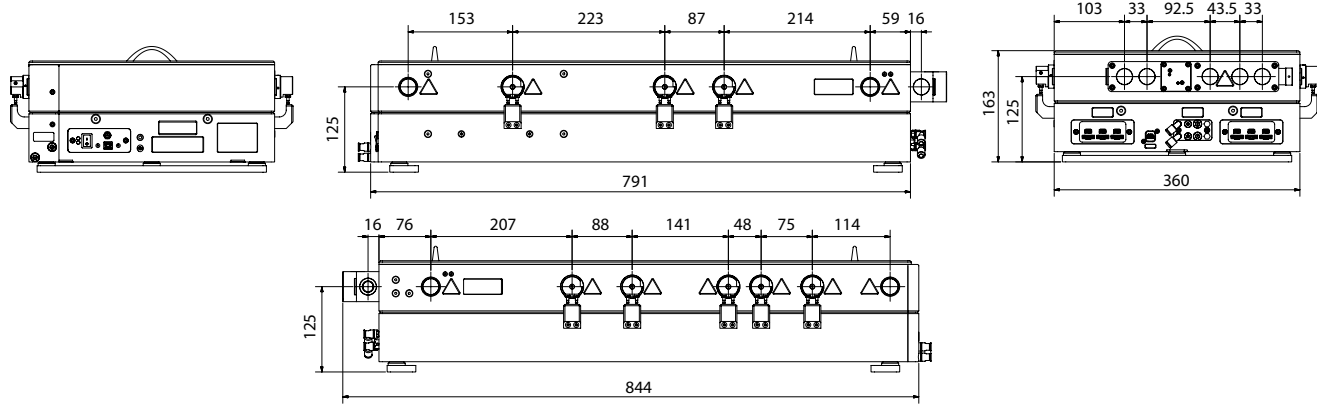

ORPHEUS-TWINS outline drawings



ORPHEUS-TWINS setup example

ORPHEUS | PS

Narrow Bandwidth Optical Parametric Amplifier

FEATURES

- Built on well-known TOPAS-800 OPA basis
- Continuously tunable picosecond pulses in 320–5000 nm
- Near bandwidth limited output, $<15 \text{ cm}^{-1}$ spectral width (typical)
- High stability is possible by seeding with femtosecond white-light continuum
- Repetition rate up to 100 kHz
- Computer-controlled

APPLICATIONS

- Stimulated Raman Spectroscopy
- Surface sum-frequency spectroscopy



ORPHEUS-PS is a narrow bandwidth optical parametric amplifier of white-light continuum, designed for PHAROS / CARBIDE pump laser. This device is pumped by the picosecond pulses produced in SHBC-515 narrow bandwidth second harmonic generator and seeded by white-light continuum generated by femtosecond pulses. This enables very high pulse to pulse stability compared to other methods of generating tunable picosecond pulses. The white-light generation module is also integrated into the same housing as the amplification modules, enabling even better long term stability and ease of

use. The system features high conversion efficiency, bandwidth and diffraction-limited output, full computer control via USB port and LabVIEW drivers. A part of the PHAROS / CARBIDE laser radiation can be split to simultaneously pump a femtosecond OPA, providing broad bandwidth 630 nm – 16 μm tunable pulses, giving access to the complete set of beams necessary for versatile spectroscopy applications, for example, narrowband Raman spectroscopy measurements, or surface sum-frequency spectroscopy.

SPECIFICATIONS

Model	ORPHEUS-PS
Tuning range	640–1010 nm signal and 1050–2600 nm idler
Pulse energy conversion efficiency	$>20 \%$ (of pump from SHBC)
Pulse energy stability	$<2.0 \%$ rms @ 700–960 nm and 1100–1500 nm
Spectral width	$<20 \text{ cm}^{-1}$ @ 700–2000 nm if pump bandwidth $<10 \text{ cm}^{-1}$
Pulse duration	1–4 ps depending on pump pulse duration from SHBC-515
SH option	Tuning range: 320–505 nm; 525–640 nm. Conversion efficiency: $>3 \%$ at peak
DFG option	Available, contact sales@lightcon.com for details

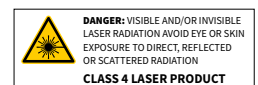

REQUIREMENTS FOR THE INPUT PULSES

- Picosecond 515 nm, produced by SHBC-515: energy 120 μJ – 1 mJ, pulse duration 1 – 3 ps, spectral width $<20\text{ cm}^{-1}$;
- Uncompressed input from SHBC is required.
- Max pump power limitation:
6 W @ 40 – 100 kHz;
8 W @ 20 – 40 kHz;
10 W @ 1 – 20 kHz.

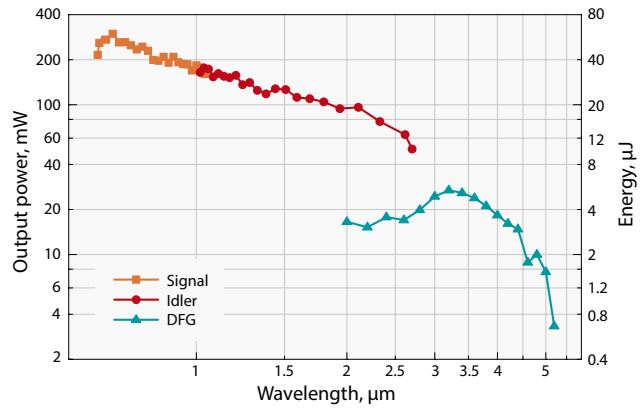

ORPHEUS-PS performance.
Pump: 2 W, 400 μJ , 5 kHz from SHBC 514.2 nm, $\Delta\lambda = \sim 8\text{ cm}^{-1}$, $\tau = 2.7\text{ ps}$

OUTLINE DRAWINGS

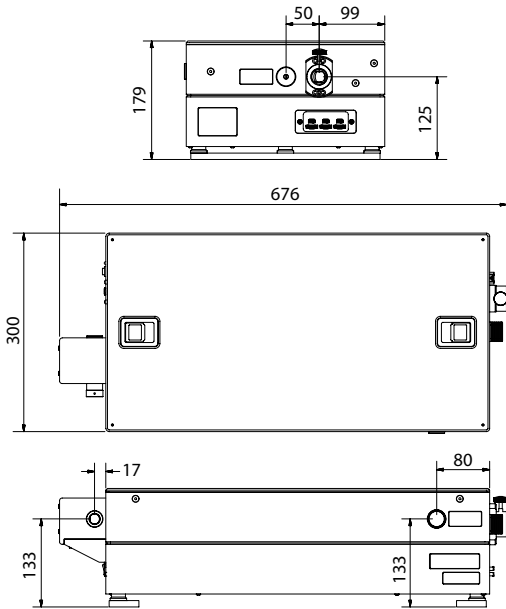

ORPHEUS-PS outline drawings

TOPAS

Optical Parametric Amplifiers for Ti:Sapphire Lasers

FEATURES

- Typical energy conversion into the parametric radiation > 25 – 30% (signal and idler combined)
- Tuning range 1160 – 2600 nm out of a single box (extendable to 189 nm – 20 μm)
- High output stability throughout across the entire tuning range
- Nearly bandwidth and diffraction-limited output
- Passive carrier-envelope phase (CEP) stabilization of the idler (1600 – 2600 nm)
- Computer-controlled operation
- Custom solutions available

TOPAS is a range of white light seeded femtosecond Optical Parametric Amplifiers (OPA), which can deliver continuous wavelength tunability from 189 nm to 20 μm, high efficiency and full computer control. With more than 1700 units installed worldwide, TOPAS has become an OPA market leader and standard tool for numerous scientific applications. TOPAS can be pumped by Ti:Sapphire amplifiers with pulse duration ranging from 20 fs to 200 fs and pulse energies from 10 μJ up to 60 mJ. Custom solutions beyond given specifications are also available.

TOPAS | HE-PRIME

High Energy Optical Parametric Amplifier

FEATURES

- Pump energy up to 60 mJ
- Energy conversion into the parametric radiation 30 – 50 %
- Tuning range spanning from 189 nm to 20 μm, computer controlled
- High output stability throughout the entire tuning range
- Fresh pump channel improves temporal and spatial properties of sum-frequency options

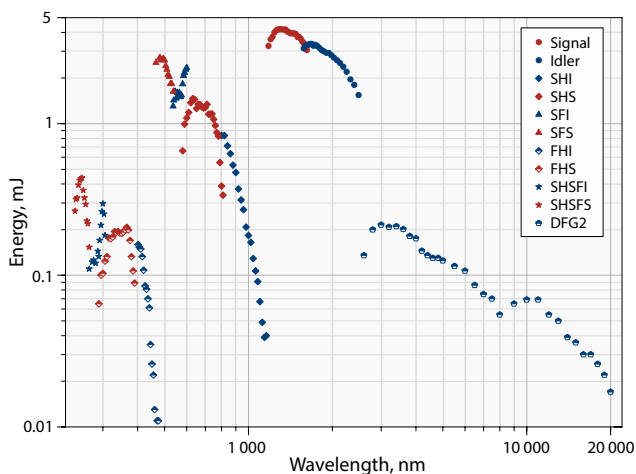

TOPAS-HE-PRIME tuning curve. Pump: 22 mJ, 45 fs, 805 nm

TOPAS-HE-PRIME is a three-stage optical parametric amplifier of white-light continuum designed for input energies higher than 5 mJ. Over 40% energy conversion efficiency to signal and idler is typically achieved. The system is compact, user-friendly and easily reconfigurable for different pump pulse parameters. Two main versions of TOPAS-HE-PRIME are available: a standard version with input energy of up to 25 mJ @ 100 fs (8 mJ @ 35 fs) and TOPAS-HE-PRIME-PLUS with input energy of up to 60 mJ @ 100 fs (20 mJ @ 35 fs). Additional custom solutions are available, e.g. higher pump energy, temperature-stabilized housing, slow loop idler-CEP stabilisation, etc.

TOPAS | PRIME

Collinear Optical Parametric Amplifier

FEATURES

- Pump energy up to 5 mJ
- Energy conversion into the parametric radiation > 30 %
- Tuning range spanning from 189 nm to 20 μm , computer controlled
- High output stability throughout the entire tuning range
- Fresh pump channel improves temporal and spatial properties of sum-frequency options



TOPAS-PRIME is a two-stage optical parametric amplifier of white-light continuum. TOPAS-PRIME offers high energy conversion efficiency (>30% typically) without compromise in spatial, spectral and temporal qualities of the output. Two main versions of TOPAS-PRIME are available: a standard version with input energy of up to 3.5 mJ @ 35 fs and TOPAS-PRIME-PLUS with increased input energy acceptance of up to 5 mJ @ 35 – 100 fs.

TOPAS | HR

High Repetition Rate Optical Parametric Amplifier

FEATURES

- Repetition rate up to 1 MHz
- Pump energy up to 0.2 mJ
- Tuning range spanning from 290 nm to 2.6 μm , computer controlled
- High output stability throughout the entire tuning range

TOPAS-HR is an optical parametric amplifier designed for high repetition rate (10 kHz – 1 MHz) applications. TOPAS-HR provides high pulse-to-pulse stability throughout the entire tuning range, high output pulse and beam quality, full automation via USB port as well as optional frequency mixing



stages for tuning range extension. TOPAS-HR can be pumped by high repetition rate Ti:Sapphire femtosecond laser amplifiers and is an invaluable tool for spectroscopy, multiphoton microscopy, micro-structuring and other applications.

TOPAS | TWINS

Two Independently Tunable Optical Parametric Amplifiers

FEATURES

- Two independently tunable outputs with single white light seed
- Energy conversion into the parametric radiation > 30 %
- Tuning range spanning from 240 nm to 20 μm in each channel, computer controlled
- High output stability throughout the entire tuning range

TOPAS-TWINS are two independently tunable optical parametric amplifiers (OPAs) integrated into single housing. Both OPAs share the same white light source to provide excellent and bound up stability of both outputs. Shared white light enables the user to generate CEP locked mid-IR pulses in 4.5 – 15 μm range. The maximum pump energy into each OPA depends on the pulse duration; see the specifications for more details. Both OPAs come with wavelength extension options, which can cover the wavelength range from 240 nm to 20 μm . Output specifications for each OPA are the same as of TOPAS-Prime.

FRESH PUMP OPTION

FOR SUM-FREQUENCY GENERATION (SFG) IN RANGE 475 – 580 nm FOR TOPAS-PRIME

DEPLETED pump option



Option when DEPLETED pump is used for SFG

FRESH pump option

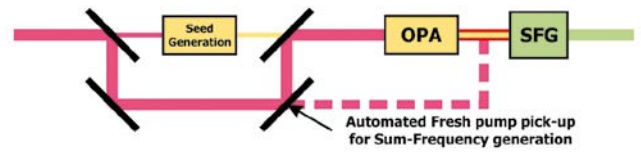

Option when FRESH pump is used for SFG

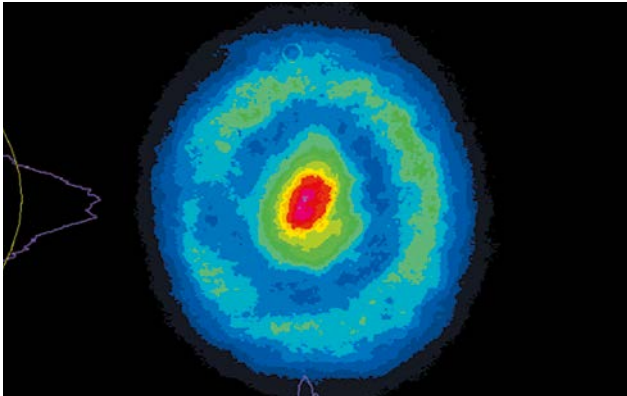

SF output profile for DEPLETED pump

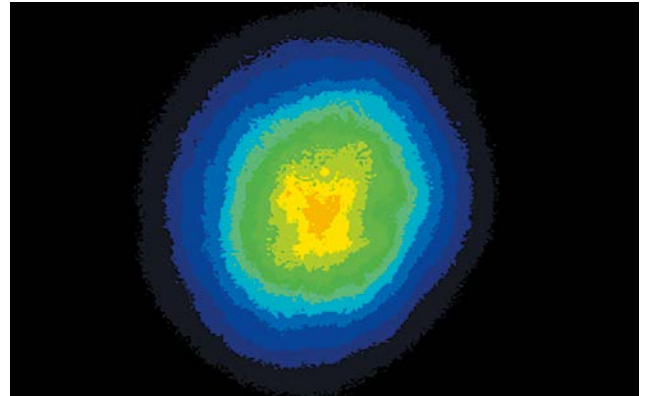

SF output profile for FRESH pump

IDLER CEP STABILIZATION KIT

TOPAS idler wave (1600 – 2600 nm) is passively CEP locked due to a three-wave parametrical interaction, however, a slow CEP drift caused by changes in pump beam pointing or environmental conditions still persists. Now we are offering a complete solution for CEP registration and slow drift

compensation. Phase correction is performed by employing an f-2f interferometer and a feedback loop controlling temporal delay between seed and pump in power amplification stage of TOPAS-PRIME or TOPAS-HE-PRIME.

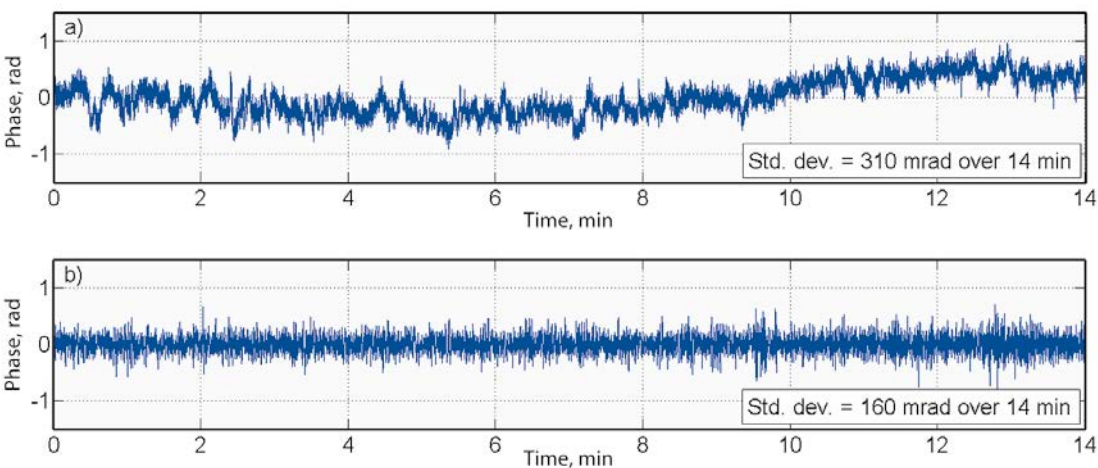

Retrieved value and computed standard deviation of the idler CEP over 14 min time range.
 (a) without compensation of drift, (b) with compensation of drift with a slow loop. Integration time 4 ms (four pulses)

NIRUVIS

Frequency Mixer

FEATURES

- Motorized wavelength tuning and separation – no manual operations
- Single output port for all wavelengths in 240–2600 nm range – same position and direction
- Automated polarization rotator for signal beam enables a more consistent output beam polarization for different interactions
- Automated signal dichroic mirror ensures good wavelength contrast ratio of SHI
- Increased conversion efficiency of idler related interactions
- Optical table layout can be U-shaped, L-shaped or in a straight line with respect to TOPAS-PRIME



NIRUVIS is an add-on frequency mixer unit for TOPAS-PRIME and HE-TOPAS-PRIME devices. It consists of three computer-controlled nonlinear crystal stages in a monolithic housing. Output is generated by employing a combination of second and fourth harmonic generation as well as sum-frequency generation. In comparison with separately standing wavelength mixing stages, NIRUVIS offers higher conversion efficiency in certain wavelength ranges, ease of operation, compact design, and low environmental sensitivity. In addition, wavelength separation is added after each nonlinear interaction ensuring high output pulse contrast.

SPECIFICATIONS

Model	Automated NIRUVIS	Standard NIRUVIS	NIRUVIS-DUV
Maximum wavelength range	240–1160 nm		189–1160 nm
Wavelength tuning	Fully automated	Manual change of wavelength separators	
Number of output ports	Single output port for all the wavelengths	4 output ports (wavelength dependent)	
FRESH pump option ¹⁾	Included	Optional	Included

¹⁾ See page 42 for details.

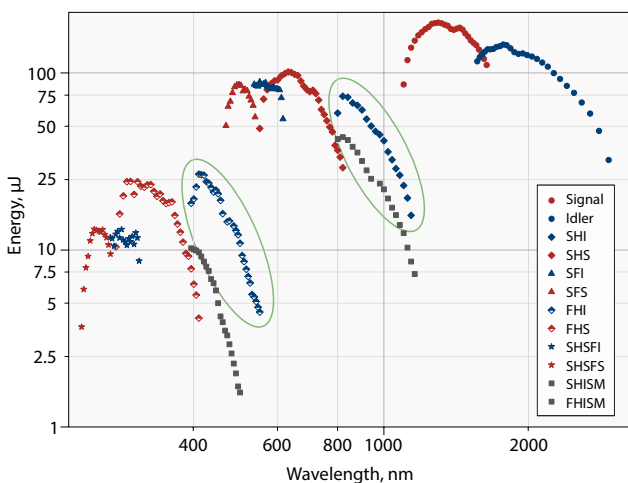
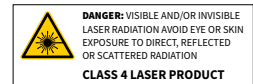

Typical TOPAS-PRIME (FRESH Pump option) + NIRUVIS output energies when pumped with 1 mJ, 100 fs, 800 nm pump. (SHISM and FHISM energies achieved with separate mixing stages)

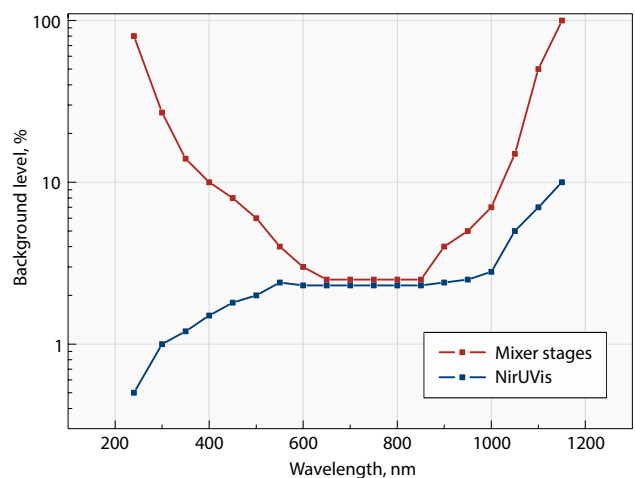

Background level comparison between NIRUVIS and separate mixing stages

OPCPA

Optical Parametric Chirped Pulse Amplification Systems

FEATURE OVERVIEW

- Customizable light sources for applications requiring the shortest pulses and extreme peak and average powers
- Wavelengths from 800 nm to 3 μm (Mid-IR extensions available)
- Peak powers up to > 5 TW
- Pulse duration down to 6.5 fs
- Repetition rates: 100 Hz to 200 kHz
- CEP stability < 250 mrad even in multi-TW peak power systems

Optical parametric chirped pulse amplification is the only currently available laser technology simultaneously providing high peak and average power, as well as few-cycle pulse duration required by the most demanding scientific applications.

LIGHT CONVERSION's answer to these demands is a portfolio of cutting-edge OPCPA products that are based on years of experience in developing and manufacturing Optical Parametric Amplifiers and Femtosecond Lasers.

OPCPA system delivering 5.5 TW peak power (6.6 fs, 36 mJ) pulses.

Built for ELI-ALPS in collaboration with Ekspla.



ORPHEUS | OPCPA

Pumped by PHAROS or CARBIDE Lasers

Benefitting from the industrial-grade stability and reliability of the PHAROS and CARBIDE series lasers, ORPHEUS-OPCPA delivers few-cycle, CEP-stable pulses in a package as compact as our standard parametric amplifiers. The different ORPHEUS-OPCPA models all use the same base architecture to produce CEP-stable, few-cycle pulses in one of the four wavelength ranges. ORPHEUS-OPCPA is available in versions with pulse compressors for direct use in applications, or, when intended as seed sources for larger amplifiers, versions delivering background-free pulses with near-single-cycle bandwidths, excellent spectral phase coherence, and CEP stability.



ORPHEUS-OPCPA-HR

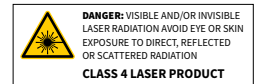

CONFIGURATIONS EXAMPLES

Wavelength	800 nm	1.6 μm	2 μm	3 μm
Pulse duration (compressed)	< 10 fs	< 40 fs	< 25 fs	< 45 fs
Transform-limited pulse duration (uncompressed, for seeding larger amplifiers)	< 6 fs	< 30 fs	< 15 fs	< 35 fs

	Repetition rate	Pulse energy / Output power			
ORPHEUS-OPCPA	10 kHz	120 μJ / 1.2 W	240 μJ / 2.4 W	180 μJ / 1.8 W	120 μJ / 1.2 W
ORPHEUS-OPCPA-HE		0.55 mJ / 5.5 W	1.1 mJ / 11 W	0.8 mJ / 8 W	0.5 mJ / 5 W
ORPHEUS-OPCPA-HR	100 kHz	25 μJ / 2.5 W	55 μJ / 5.5 W	40 μJ / 4 W	30 μJ / 3 W
ORPHEUS-OPCPA-HP		100 μJ / 10 W	220 μJ / 22 W	150 μJ / 15 W	120 μJ / 12 W

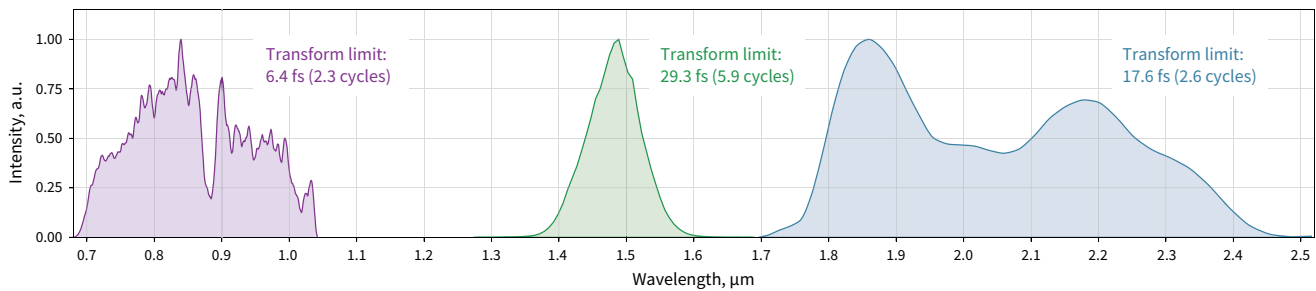

Example spectra of three models of ORPHEUS-OPCPA

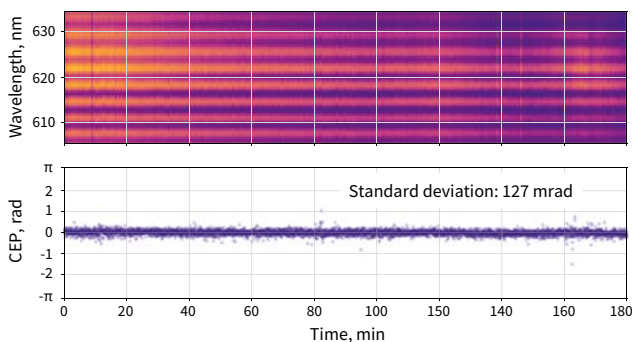

ORPHEUS-OPCPA CEP stability (800 nm, 100 kHz version)
All CEP values calculated from unaveraged, single-shot measurements!

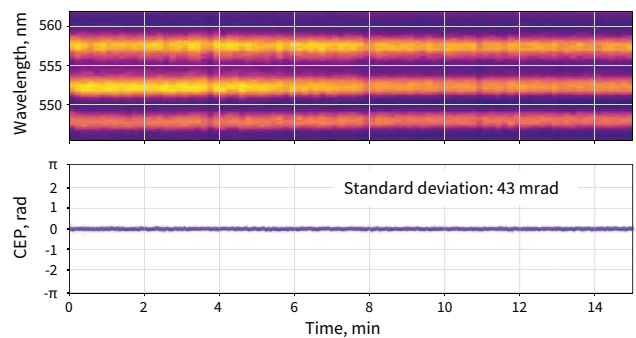

ORPHEUS-OPCPA CEP stability (3 μm , 1 kHz version)
All CEP values calculated from unaveraged, single-shot measurements!

OPCPA | HR

Pumped by InnoSlab or Thin-Disk Lasers, Optionally Seeded by ORPHEUS-OPCPA

InnoSlab and thin-disk lasers based on Yb:YAG are the state-of-the-art high average power lasers of today. These lasers lend themselves extremely well to pumping OPCPA systems, and LIGHT CONVERSION is happy to offer OPCPA solutions designed to work with these lasers. Available either bundled with state-of-the-art multi-100 W lasers or as standalone modules designed to work with your laser.

- Wavelength(s), pulse durations and energy are customizable – contact sales@lightcon.com for more details.
- A single pump laser can be combined with more than one OPCPA option in either switchable or split-energy operation.

CONFIGURATIONS EXAMPLES

Wavelength	800 nm	1.6 μm	2 μm	3 μm
Pulse duration	< 9 fs	< 35 fs	< 25 fs	< 35 fs
	Repetition rate	Pulse energy / Output power		
HR-20	20 kHz	0.8 mJ / 16 W	1.6 mJ / 32 W	1.3 mJ / 26 W
HR-200	200 kHz	110 μJ / 22 W	270 μJ / 54 W	200 μJ / 40 W
			1.3 mJ / 26 W	0.8 mJ / 16 W
			200 μJ / 40 W	130 μJ / 26 W

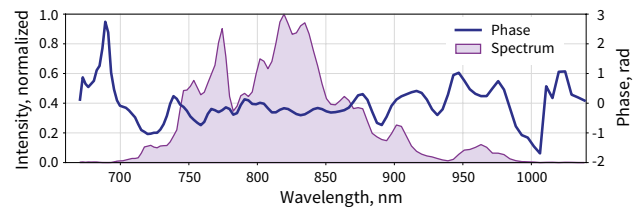
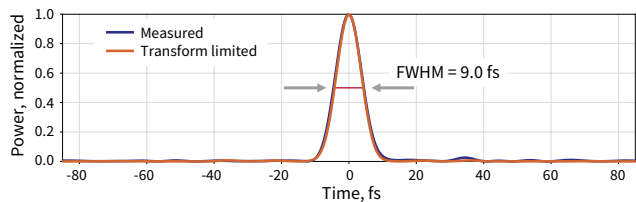

OPCPA-HR output pulse measurement

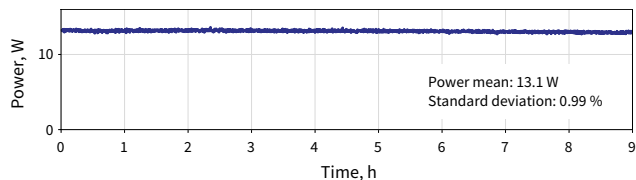

9-hour measurement of a 100 kHz, 800 nm OPCPA-HR power.
Standard deviation: < 1 %

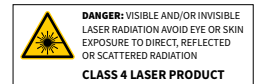

Mid-Infrared Wavelength Extensions for OPCPA For ORPHEUS-OPCPA and OPCPA-HR

2 μm models of ORPHEUS-OPCPA and OPCPA-HR can be equipped with an extra module for efficiently generating tunable broadband MIR pulses. Contact sales@lightcon.com for more details.

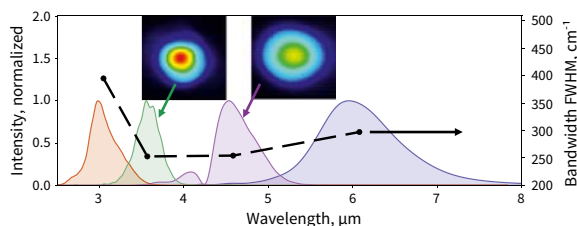

Example spectra measured from ORPHEUS-OPCPA DFG module

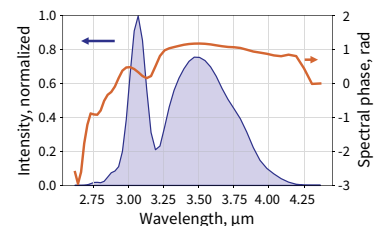
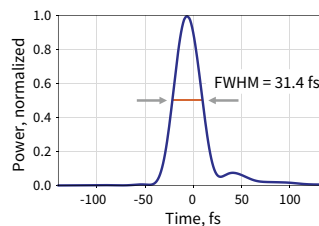

ORPHEUS-OPCPA DFG output spectrum and pulse at 3.4 μm

OPCPA | HE

Pumped by Picosecond Nd:YAG Lasers, Seeded by ORPHEUS-OPCPA

Applications like high energy attosecond pulse generation, generation of high harmonics from solid targets, and laser electron acceleration all benefit from few-cycle pulse durations and excellent pulse contrast while requiring multi-millijoule pulse energy. Our most powerful systems, scalable to multi-TW peak powers at kHz repetition rate while maintaining few-cycle pulse durations, will fit the most demanding requirements, while providing stability and reliability unprecedented for systems of this scale.



SYLOS has been launched in ELI-ALPS facility in Hungary on 15th of May, 2019

CONFIGURATIONS EXAMPLES

Wavelength	800 nm	900 nm	1.6 μm	2 μm
Pulse duration	< 9 fs	< 6.5 fs	< 50 fs	< 30 fs
	Repetition rate		Pulse energy / Output power	
HE-100 ¹⁾	100 Hz	50 mJ	35 mJ	100 mJ
HE-1000 ²⁾	1 kHz	50 mJ / 50 W	35 mJ / 35 W	100 mJ / 100 W

- 1) Cost-effective highly-stable multi-TW source.
- 2) Cutting-edge combination of peak and average power.

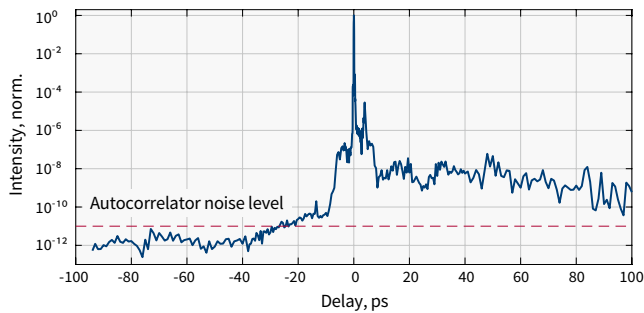
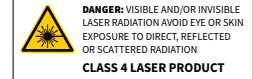

High-dynamic-range third order autocorrelation measurement of an OPCPA-HE system

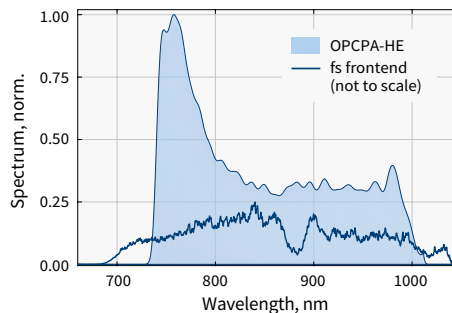

OPCPA-HE output spectrum

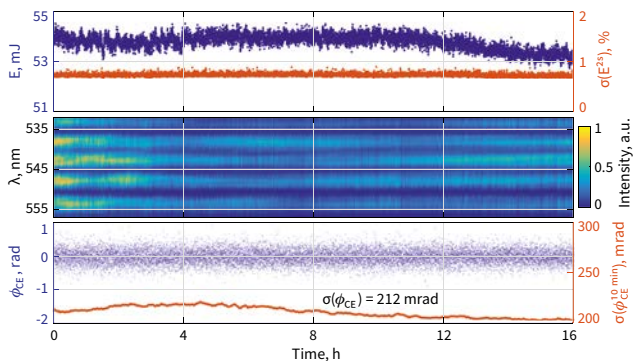

OPCPA-HE pulse energy, f-2f interferogram and CEP stability measured during a 16-hour test run

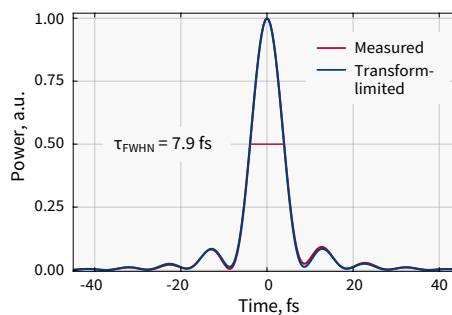

Temporal profile of OPCPA-HE output pulses measured with a self-referenced spectral interferometry device

HARPIA

Comprehensive Spectroscopy System



The HARPIA comprehensive spectroscopy system performs a variety of sophisticated time-resolved spectroscopy measurements in a compact footprint. It also offers an intuitive user experience and easy day-to-day maintenance meeting the needs of today's scientific applications. Despite its small size, the HARPIA system is easily customizable and can be tailored to specific measurement needs.

The system is configured around the HARPIA-TA transient absorption spectrometer and can be expanded using time-correlated single-photon counting and fluorescence upconversion (HARPIA-TF), third beam delivery (HARPIA-TB) and microscopy modules. Switching between different measurement modes is mostly automated and requires very little user interaction.

Adhering to the standards set by the ORPHEUS product line, each module is contained in a single monolithic aluminium body ensuring excellent optical stability and minimal optical path lengths. For a robust and versatile single-supplier solution the HARPIA spectroscopy system can be combined with a PHAROS or a CARBIDE laser together with ORPHEUS series OPAs. HARPIA also supports Ti:Sa lasers with TOPAS series OPAs.

MEASUREMENT MODES:

- Femtosecond transient absorption and reflection
- Femtosecond transient absorption and reflection microscopy
- Femtosecond multi-pulse transient absorption and reflection
- Femtosecond fluorescence upconversion
- Picosecond-to-microsecond fluorescence using TCSPC
- Intensity-dependent transient absorption and reflection, time-resolved fluorescence
- Time-resolved femtosecond stimulated Raman scattering (FSRS)
- Flash photolysis

STANDARD CONFIGURATIONS

Ultrafast Transient Absorption, TCSPC and Fluorescence Upconversion Spectroscopy



Ultrafast Multi-pulse Transient Absorption Spectroscopy



Ultrafast Multi-pulse Transient Absorption, TCSPC and Fluorescence Upconversion Spectroscopy



HARPIA | TA

Ultrafast Transient Absorption Spectrometer

APPLICATION FIELDS

- Photochemistry
- Photobiology
- Photophysics
- Material science
- Semiconductor physics
- Time-resolved spectroscopy



The HARPIA-TA ultrafast transient absorption spectrometer features market-leading characteristics such as 0.05 mOD ($10^{-4} \Delta T/T$) sensitivity and the ability to work at high repetition rates up to 1 MHz, when used with a PHAROS or a CARBIDE laser and an ORPHEUS OPA. A high repetition rate allows measuring transient absorption dynamics, while exciting the samples with low pulse energies down to several nanojoules. Several probe configurations and detection options are available: from simple and cost-effective photodiodes for single-wavelength detection, to white-light supercontinuum probing, combined with spectrally-resolved broadband detection. HARPIA-TA features integrated data acquisition and measurement control electronics providing advanced features such as:

- Single (sample-only) or multiple (sample and reference) integrated spectral detectors
- Simple integration of an external spectrograph
- Automated pump and probe beam position tracking and alignment
- Straightforward switching between transient absorption and transient reflection measurements

Several delay line options are available to cover delay ranges from 2 ns to 8 ns using either linear leadscrew (20 mm/s) or fast ball-screw (300 mm/s) translation stages.

Various optomechanical peripherals and electronics are integrated in HARPIA including:

- Optical chopper which can be synchronized to an external trigger
- Motorized Berek polarization compensator to adjust the polarization of the pump beam
- Motorized translating supercontinuum generator (for use with CaF_2 or MgF_2)
- Automated sample mover to translate the sample in the focal plane, thus avoiding local sample overexposure
- Integrated computer and data acquisition electronics
- Sample stirrer
- Beam profiler

HARPIA-TA is compatible with many cryostats and peristaltic pumps. The capabilities of the spectrometer can be further extended using expansion modules.

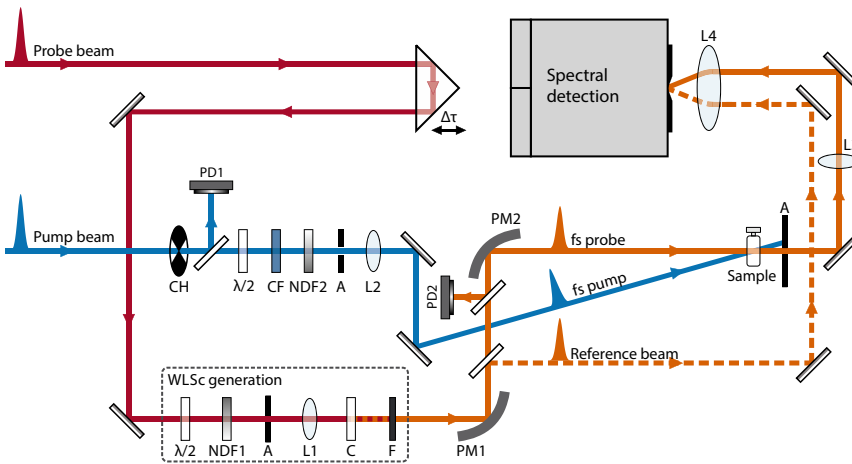

HARPIA-TA optical layout for pump-probe experiments

SPECIFICATIONS

Probe wavelength range, white light supercontinuum generator pumped by 1030 nm	480 – 1100 nm
Probe wavelength range, white light supercontinuum generator pumped by 515 nm	350 – 750 nm
Probe wavelength range, white light supercontinuum generator pumped by 800 nm	350 – 1100 nm
Spectral range of multichannel detectors	200 – 1100 nm, 700 – 1800 nm or 1.2 – 2.6 μm
Spectral range of single-channel detectors	180 nm – 24 μm
Delay range	4 ns, 6 ns or 8 ns
Delay resolution	4.2 fs, 6.3 fs or 8.3 fs
Laser repetition rate	1 – 1000 kHz
Time resolution	<1.4x of pump or probe pulse duration, whichever is longer
Physical dimensions, L×W×H	730 × 420 × 160 mm ¹⁾
Sample chamber area	205 × 215 mm

¹⁾ Without external spectrograph.

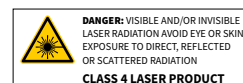

Custom cryostat mounting option

OUTLINE DRAWINGS

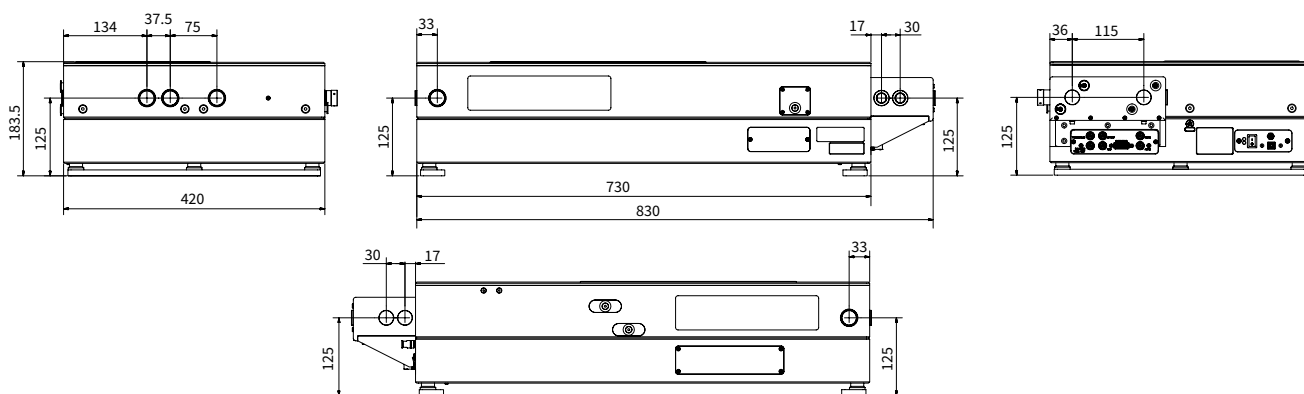

HARPIA-TA outline drawings

HARPIA | TF

Femtosecond Fluorescence Upconversion and TCSPC Module

FEATURES

- Combined femtosecond upconversion and TCSPC measurement in a small footprint
- Straightforward operation and easy day-to-day maintenance
- Works as an add-on to a HARPIA-TA or as a standalone unit
- Easy switching between fluorescence upconversion and TCSPC modes
- Compatible with PHAROS and CARBIDE series lasers running at 50 – 1000 kHz
- Analog PMT detector option for fluorescence upconversion
- Automated spectral scanning and calibration of upconversion crystal and prism
- Measurement of fluorescence dynamics in the femtosecond to microsecond range
- Full control over the following parameters of the pump beam:
 - Polarization (using a Berek polarization compensator)
 - Intensity (using manual or automated continuously variable neutral density filters)
 - Gate delay (using an optical delay line)
- Spectrally-resolved fluorescence detection using a monochromator
- When combined with a HARPIA-TA main unit, a single monochromator can be used for both time-resolved absorption and fluorescence measurements with no detector swapping necessary. Other monochromator options are available, such as a double subtractive monochromator for higher TCSPC time resolution



The HARPIA-TF is a time-resolved fluorescence measurement module which combines fluorescence upconversion and TCSPC techniques. In fluorescence upconversion, the signal from the sample is mixed in a nonlinear crystal with a gating femtosecond pulse to achieve high temporal resolution, which is limited by the duration of the gate pulse and is in the range of 250 fs. For fluorescence decay times exceeding 150 ps, the instrument can be used in time-correlated single-photon counting (TCSPC) mode to measure kinetic traces in the 200 ps – 2 μs range. The HARPIA-TF module supports Becker&Hickl TCSPC devices and detectors.

The combination of these two time-resolved fluorescence techniques enables the measurement of spectrally-resolved fluorescence decay in the femtosecond to microsecond range. With the use of a high repetition rate PHAROS or CARBIDE laser, the fluorescence dynamics can be measured while exciting the samples with low pulse energies down to several nanojoules.

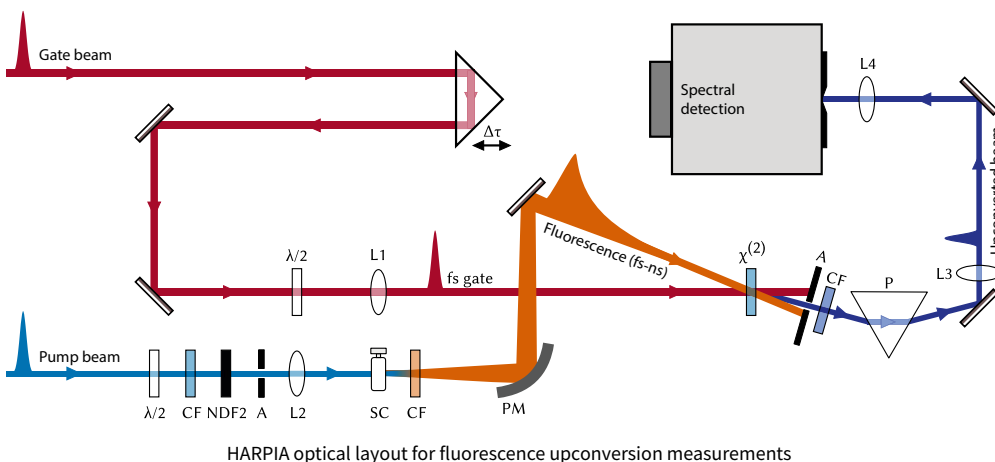

HARPIA optical layout for fluorescence upconversion measurements

SPECIFICATIONS

TCSPC MODE

TCSPC module	Becker&Hickl SPC 130 ¹⁾
Photomultiplier	Becker&Hickl PMC-150 or HPM-100
Emission wavelength range	300 – 820 nm
Intrinsic time resolution	<200 ps
Time resolution with monochromator	<1.2 ns ²⁾
SNR	< 100 : 1, assuming 5 s averaging per trace ³⁾

UPCONVERSION MODE

Wavelength range	300 – 1600 nm ⁴⁾
Wavelength resolution	Limited by the bandwidth of the gating pulse, typically around 100 cm ⁻¹
Delay range	4 ns, 6 ns or 8 ns
Delay resolution	4.2 fs, 6.3 fs or 8.3 fs
Time resolution	< 1.4× of the pump or probe pulse duration, whichever is longer, 420 fs with a PHAROS laser ⁵⁾
SNR	65:1, assuming 0.5 s averaging per point ⁶⁾

¹⁾ Visit www.becker-hickl.de for specifications.

²⁾ Estimated as the FWHM of the upconverted white-light supercontinuum generated in the sample.

³⁾ Estimated by fitting a kinetic trace measured in Rhodamine 6G solution at 580 nm with multiple exponents, subtracting the fit from the data and taking the ratio between the standard deviation of the residuals and the 0.5 × maximum signal value. Laser repetition rate 250 kHz. Not applicable to all samples and configurations.

⁴⁾ Depending on the gating source, full range covered with different nonlinear crystals.

⁵⁾ Estimated as the FWHM of the upconverted white-light supercontinuum generated in the sample or the derivative of the rise of the upconversion signal.

⁶⁾ Estimated as the standard deviation of a set of 100 points at 50 ps intervals measured in Rhodamine 6G dye at an upconverted wavelength of 360 nm using a PHAROS laser running at 150 kHz repetition rate. Not applicable to all samples and configurations.

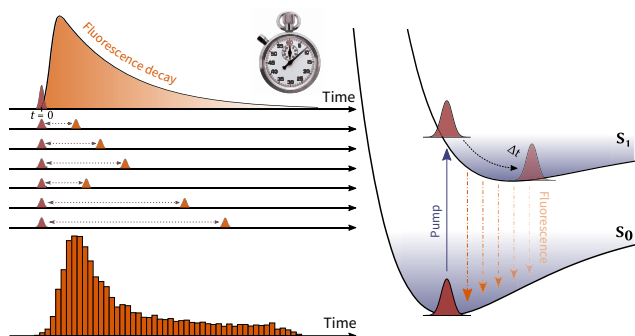
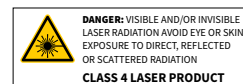

Principle of time-correlated single-photon counting (TCSPC)

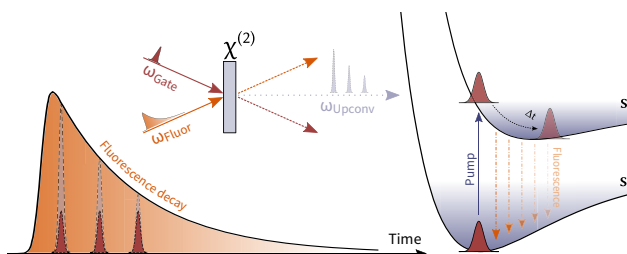

Principle of time-resolved fluorescence upconversion

HARPIA | TB

Third Beam Delivery Module

FEATURES

- Can be installed as an add-on to a HARPIA-TA
- Provides an additional temporal dimension to pump-probe measurements
- Provides additional insight into complex photodynamic systems
- Full control of the third beam:
 - Polarization (using a manual or automated Berek polarization compensator)
 - Intensity (using a manual or an automated continuously variable neutral density filter)
 - Delay (using an automated 2 ns or 4 ns optical delay line)
- Z-scan support



When standard spectroscopy tools are not enough to unravel the intricate ultrafast dynamics of photoactive systems, multi-pulse time-resolved spectroscopic techniques can be utilized to yield additional insight. The HARPIA-TB is a third beam delivery module for the HARPIA-TA main unit that adds an additional dimension to time-resolved absorption measurements. It allows an additional temporally-delayed laser pulse to be introduced before or during the pump-probe interaction in order to perturb the ongoing photodynamics.

In a pump-dump-probe (PDP) configuration, an auxiliary pulse resonant to a stimulated emission transition band can deliberately depopulate the excited state and thereby revert the excited system back to the ground state.

In a pump-repump-probe (PrPP) configuration, the wavelength of the additional pulse corresponds to an induced absorption resonance and thus is able to elevate the system to a higher excited state (which may or may not be detectable in the nonperturbed photoevolution), or return it to an earlier transient state.

In a pre-pump-pump-probe (pPPP) configuration, the auxiliary pulse is resonant to an electronic ground-to-excited state transition, i.e., $S_0 \rightarrow S_n$, which makes it possible to either replenish the excited state population or to prepare a small portion of the excited state population before the main pump pulse.

Since the probe and the auxiliary pulse can be delayed in time with respect to each other, kinetic trace and action trace experiments can be performed using a HARPIA-TB module. In kinetic trace mode, the evolution of the system perturbed by the additional pulse is tracked by scanning the time delay of the probe pulse. In action trace mode, the influence of the exact timing of the perturbation is investigated by scanning the delay of the additional pulse.

Moreover, HARPIA-TB can be utilized to deliver frequency-narrowed picosecond pulses, thus providing the capability to perform time-resolved femtosecond stimulated Raman scattering (FSRS) measurements.

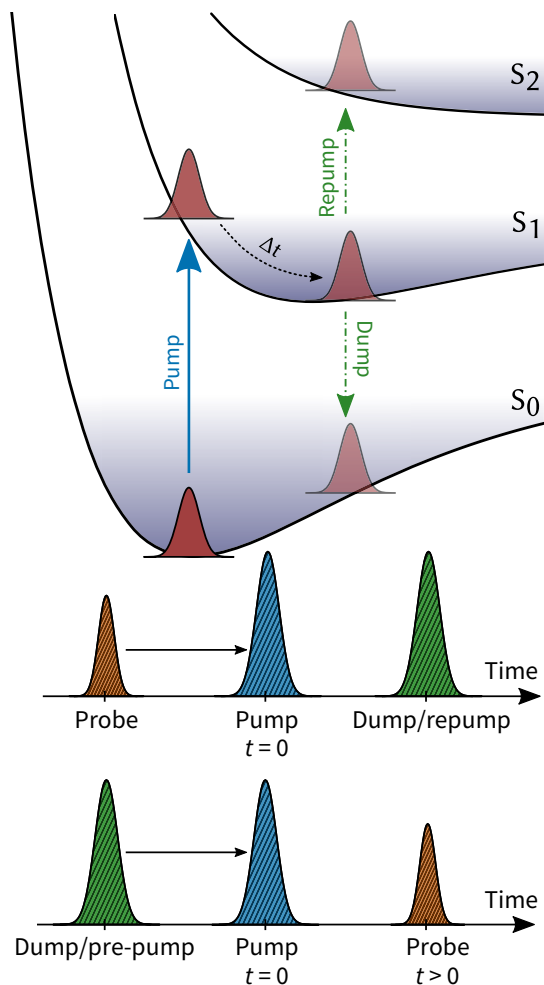

State transitions and pulse timing in multi-pulse time-resolved transient absorption spectroscopy

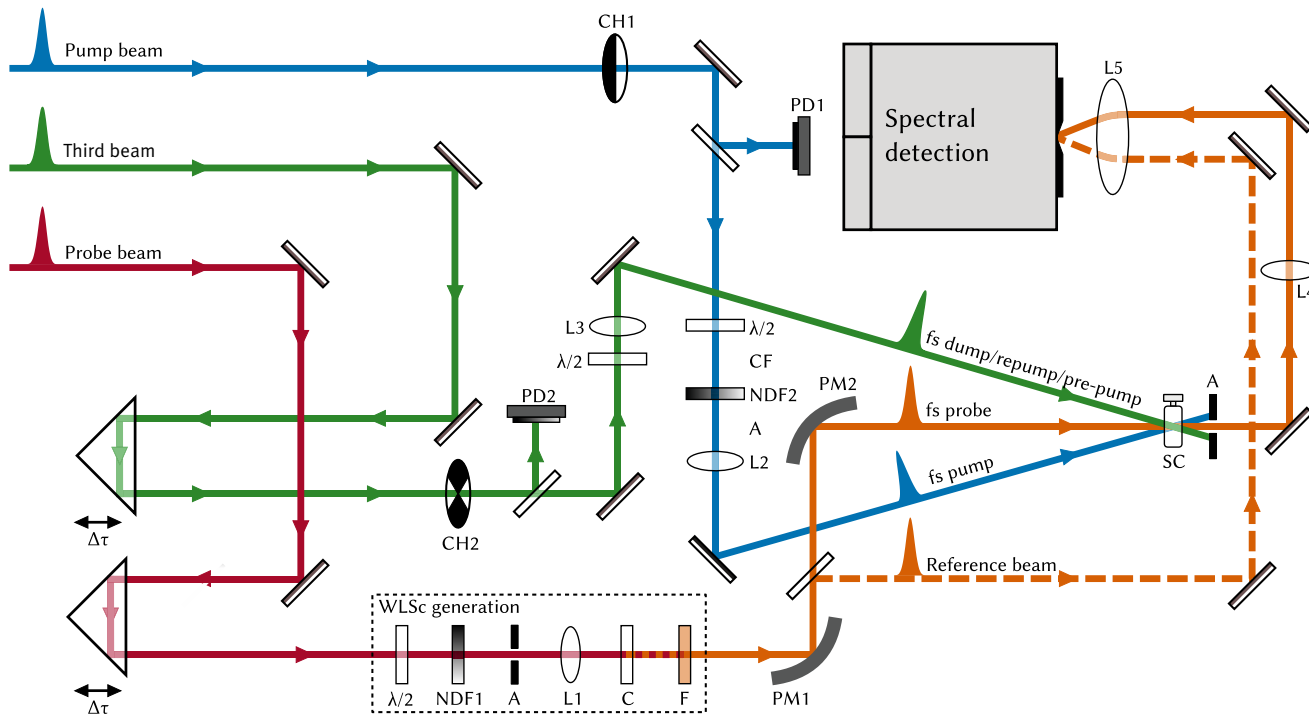

HARPIA optical layout for multi-pulse experiments

OUTLINE DRAWINGS

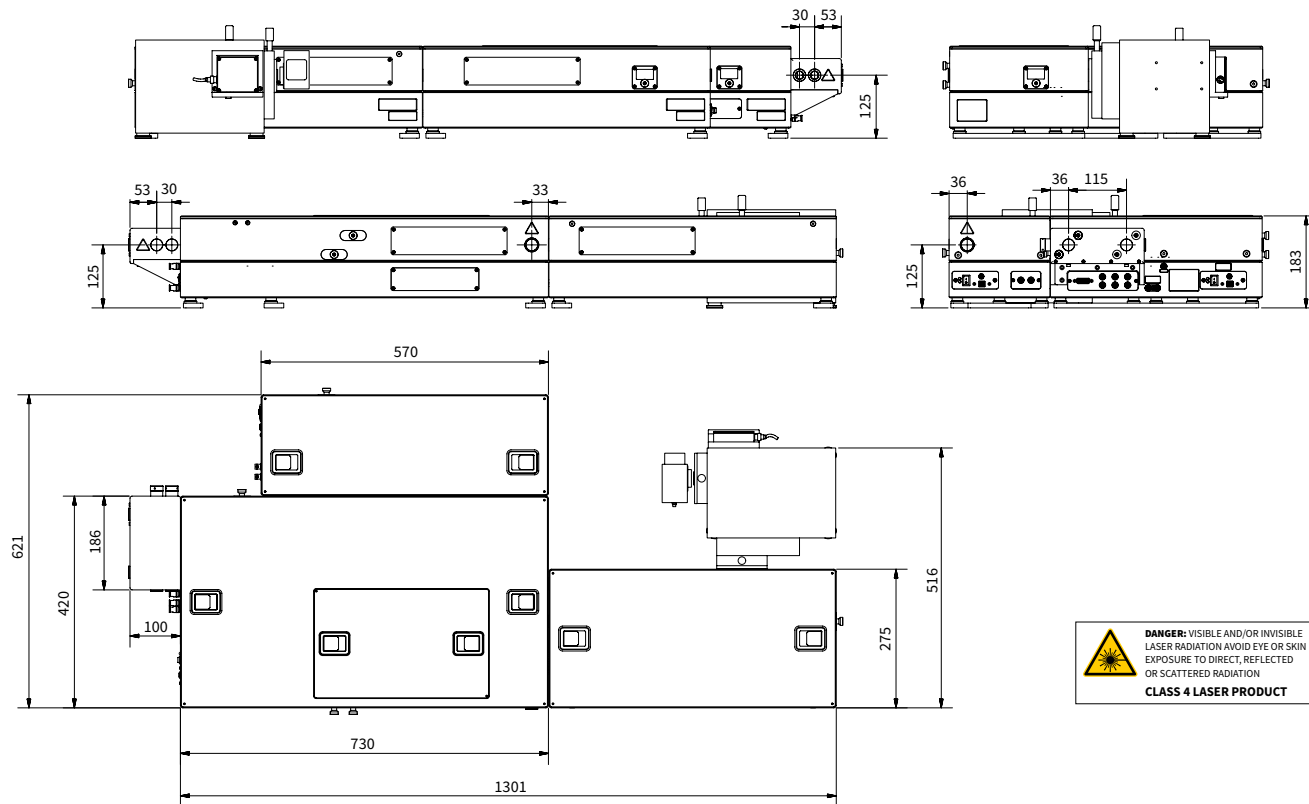

Outline drawings of HARPIA system with HARPIA-TB and HARPIA-TF modules

HARPIA



Microscopy Module

The microscopy module is an add-on to a standard HARPIA-TA body and enables spatially-resolved pump-probe measurements with a sub-5 μm resolution. Broadband and monochromatic probe beam options are supported. The user can switch between bulk and microscopic pump-probe modes without disturbing the sample by swapping self-contained bulk and microscopy modules that are mounted on kinematic bases. A 3D motorized stage allows the sample to be positioned and scanned in a $13 \times 13 \times 13 \text{ mm}^3$ volume. Samples of various thicknesses can be accommodated using an optional motorized objective stage. The sample holder comes with cassettes for various sample types and sizes. The module can be configured in either transmission or reflection geometry, and the sample can be observed using a conventional brightfield mode to determine the pump-probe spot position.



SPECIFICATIONS

Spatial resolution	5 μm
Working distance	15 mm
Spectral range	480 – 1100 nm
Temporal resolution	500 fs
Sample motion range	$13 \times 13 \times 13 \text{ mm}^3$



Switching between bulk and microscopic pump-probe modes can be done without disturbing the sample

TRANSMISSION MODE

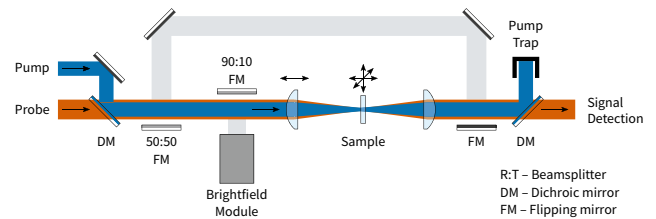

REFLECTION MODE

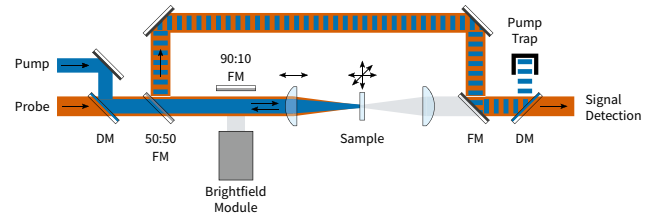

BRIGHTFIELD MODE

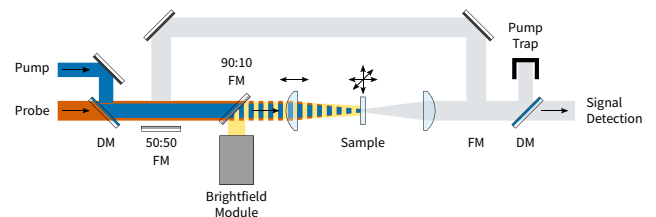

HARPIA Software

HARPIA SOFTWARE

A single application for transient absorption, fluorescence upconversion and TCSPC measurements, featuring:

- Intuitive and user-friendly interface
- Wizards to guide measurements and calibration
- Measurement presets
- Optional advanced measurement post-processing (data balancing for noise suppression, signal saturation detection, outlier detection, etc.)
- Diagnostics and data export tools
- REST API for remote experiment control using third-party software
- API examples using LabView, Python and MATLAB
- Automatic software update

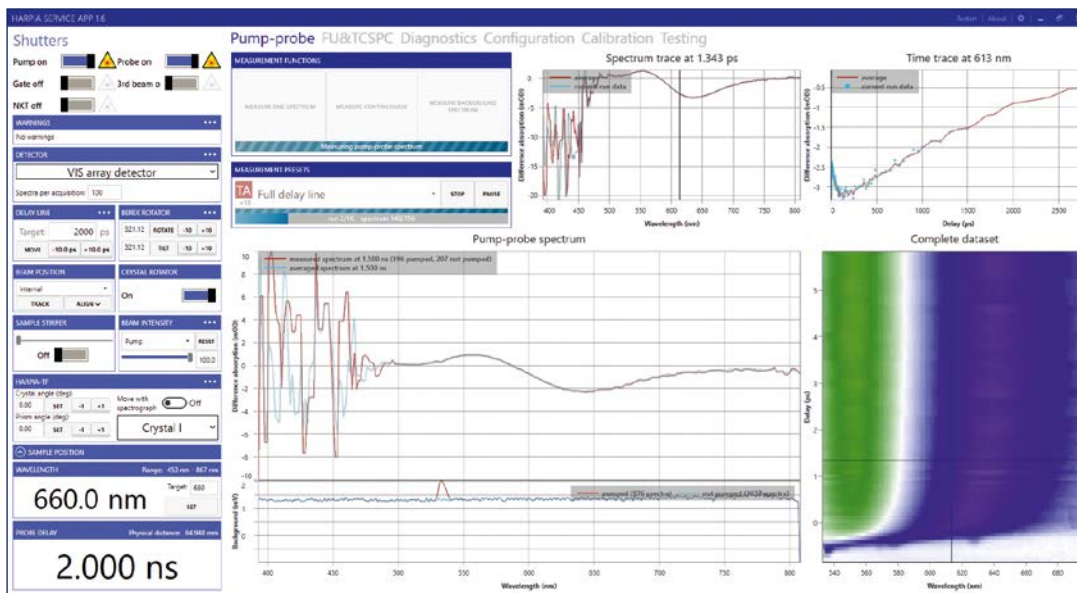

HARPIA Software main window

CARPETVIEW DATA ANALYSIS SOFTWARE

An advanced ultrafast spectroscopy data analysis application, featuring:

- Advanced visualization and data export tools
- Publication-quality graph preparation
- Advanced data wrangling: slicing, merging, cropping, shifting, smoothing, fitting, subtracting, etc.
- Probe spectral chirp correction and calibration using a reference transient absorption spectrum
- Advanced global and target analysis:
 - Fitting to user-defined physical compartment model
 - Probe spectral chirp correction and deconvolution with an instrument response function
- Support for three-dimensional data sets (2D electronic spectroscopy, fluorescence lifetime imaging)

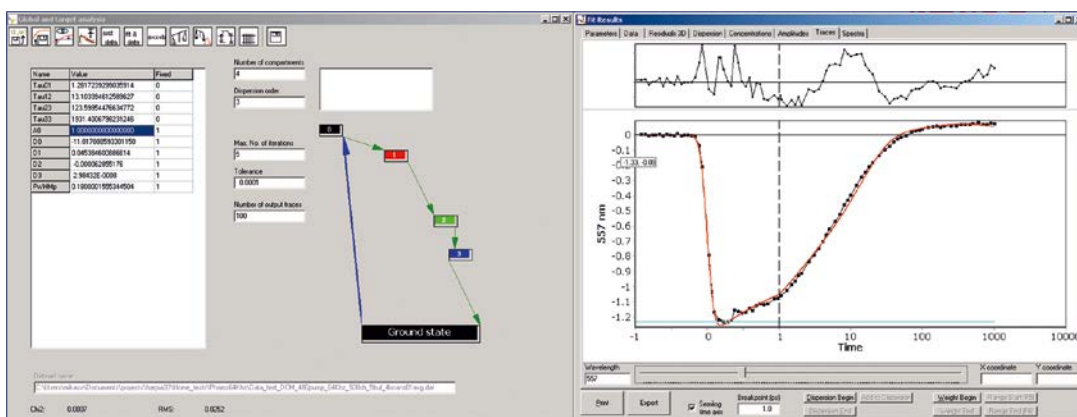

Global and target analysis window of CarpetView

HARPIA Data Samples

FEMTOSECOND PUMP-PROBE

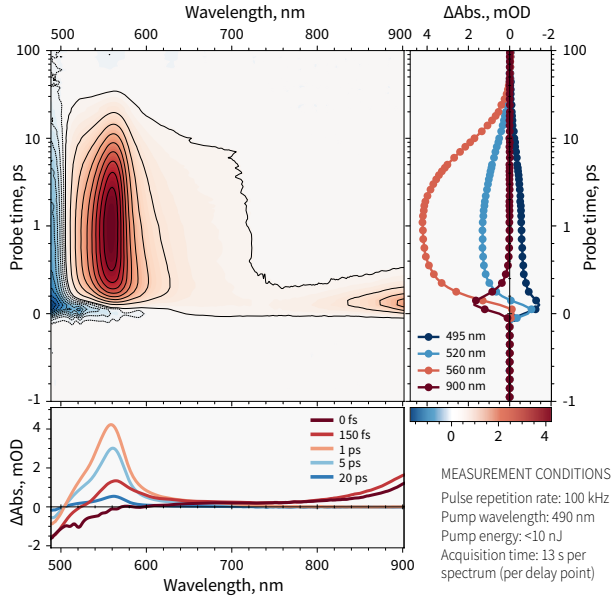

Spectral dynamics of beta-carotene in solution acquired using HARPIA-TA

FLUORESCENCE UPCONVERSION

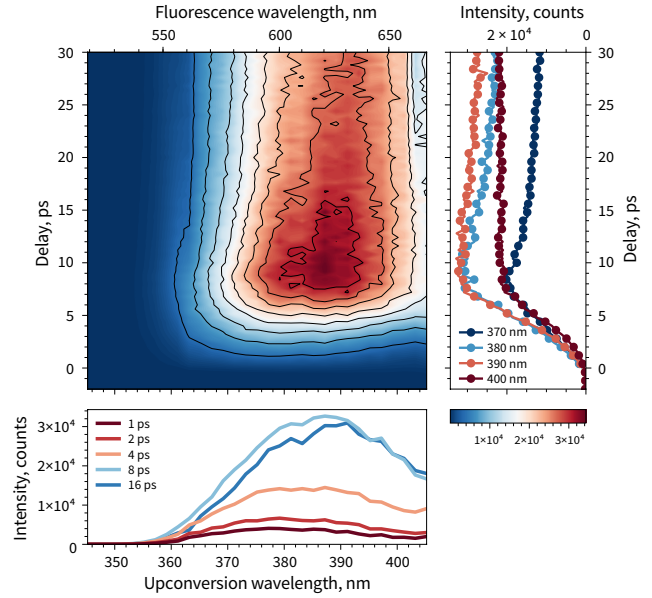

Fluorescence dynamics of DCM laser dye in solution acquired using HARPIA-TF in fluorescence upconversion mode

FEMTOSECOND PUMP-PROBE MICROSCOPY

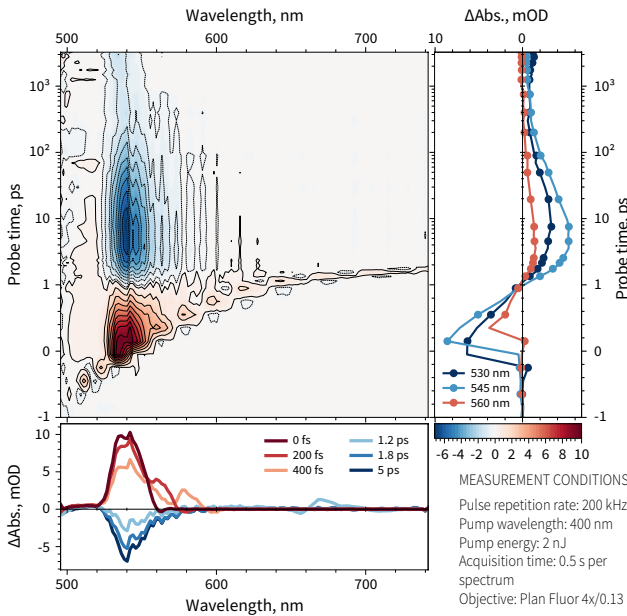

Single perovskite crystallite pump-probe spectral kinetics, pump at 400 nm

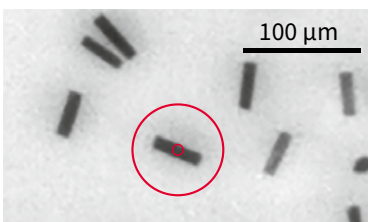

Pump-probe spot marked by the small circle

HARPIA PERFORMANCE AT HIGH REPETITION RATES

The HARPIA spectroscopy system achieves an excellent signal-to-noise ratio at high repetition rate and low energy excitation conditions. The graphs below compare the SNR of difference absorption spectra obtained with a Ti:Sapphire laser running at 1 kHz and a PHAROS laser running at 64 kHz with the same acquisition time.

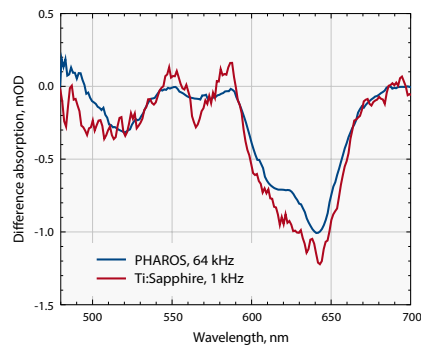

Measured difference absorption spectra of CdSe/ZnS quantum dots using low- and high-repetition rate lasers with 5 s acquisition time

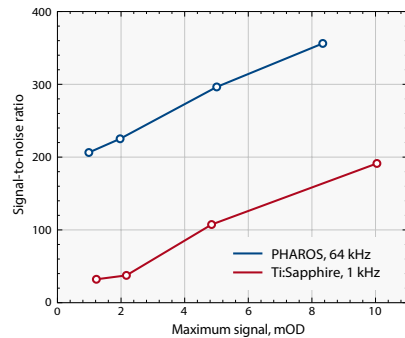

Best-effort signal-to-noise ratios, achieved with HARPIA-TA spectrometer driven by a Ti:Sapphire laser operating at 1 kHz (red) and a PHAROS laser operating at 64 kHz (blue)

IR FEMTOSECOND PUMP-PROBE

Pump-probe dynamics of GaAs wafer in IR measured using signal and reference single-channel detectors

MEASUREMENT CONDITIONS
 Pulse repetition rate: 75 kHz
 Pump wavelength: 700 nm
 Acquisition time: 1 s per point

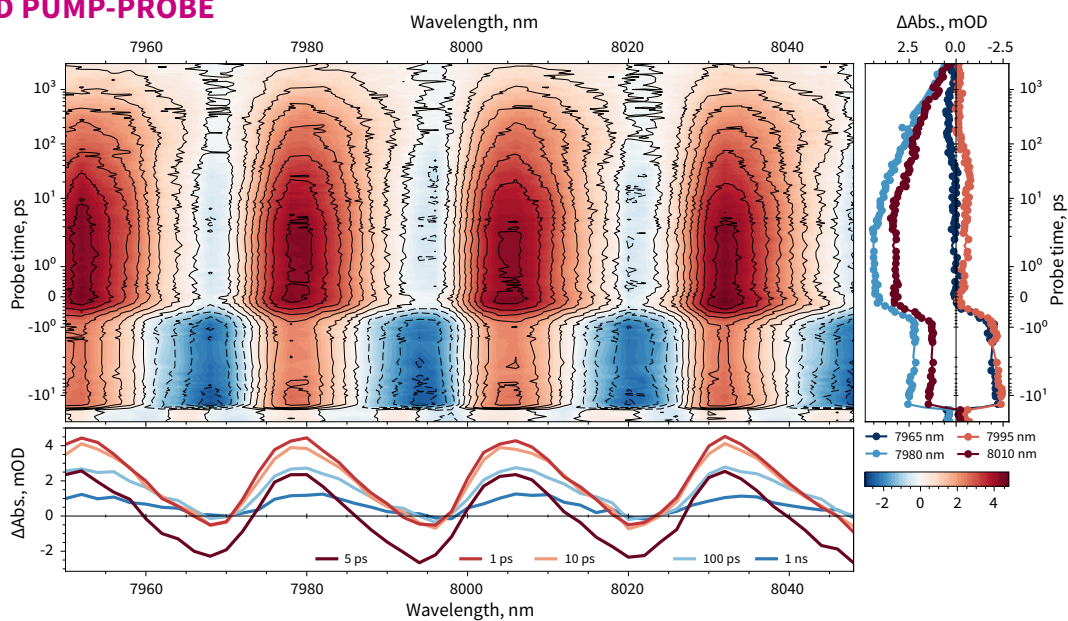

FEMTOSECOND PUMP-DUMP-PROBE

Pump-dump-probe dynamics of DCM laser dye with dump pulse resonant to the emission band of DCM

MEASUREMENT CONDITIONS
 Pulse repetition rate: 50 kHz
 Pump wavelength: 515 nm
 Dump wavelength: 700 nm
 Dump delay: 21 ps
 Pump energy: 90 nJ
 Dump energy: 190 nJ

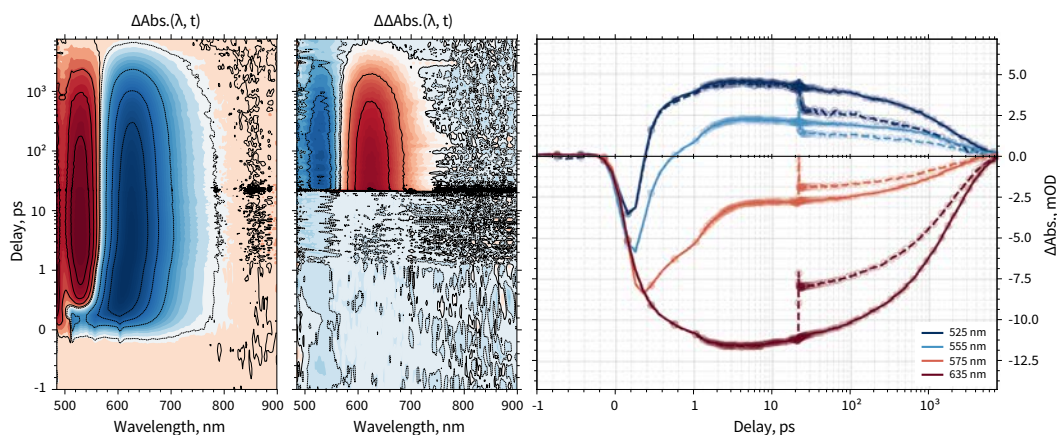

FLASH PHOTOLYSIS

Nanosecond spectral dynamics of meso-Tetraphenylporphine in solution acquired using HARPIA in flash photolysis mode

MEASUREMENT CONDITIONS
 Pulse repetition rate: 1.8 kHz
 Pump wavelength: 343 nm
 Pump energy: 5.4 μJ

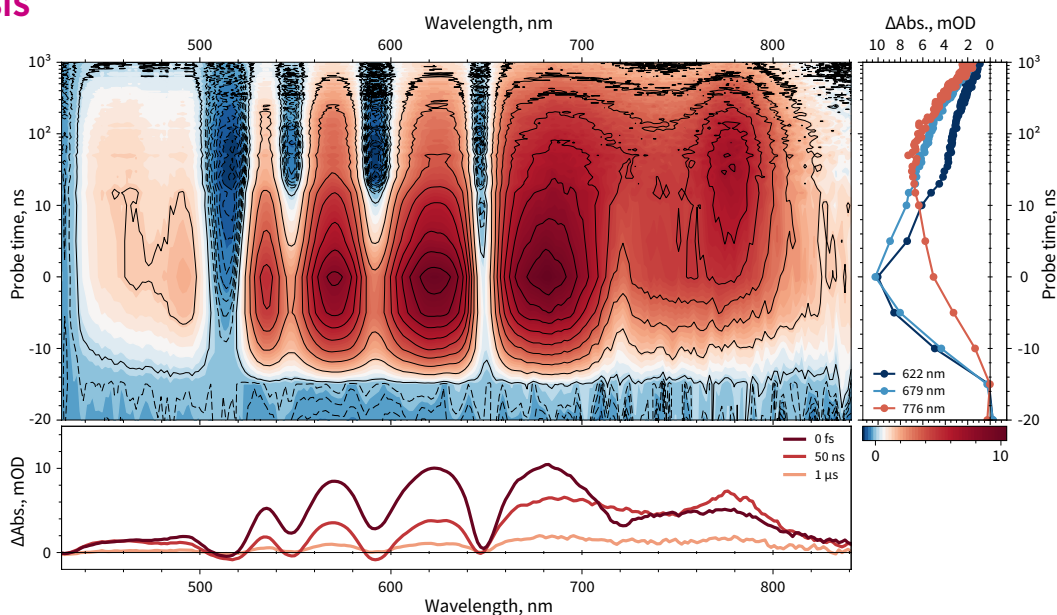

GECO

Scanning Autocorrelator

FEATURES

- Measures pulse duration in 10 fs – 20 ps range
- Single set of optics for 500 – 2000 nm range
- High-resolution voice coil driven delay line
- Non-collinear intensity and collinear interferometric autocorrelation traces
- Onboard pulse-analysis software for pulse duration measurements
- Integrated controller and computer
- Non-dispersive polarization control
- FROG ready

Operation of GECO autocorrelator is based on noncollinear second-harmonic generation in a nonlinear crystal, producing intensity autocorrelation trace directly related to the input beam pulse duration. One arm of the fundamental pulse is delayed by means of a magnetic linear positioning stage, providing fast, reliable motion with < 0.15 fs resolution. GECO can acquire a full intensity autocorrelation trace of 10 fs to 20 ps pulses and covers the full 500 nm to 2000 nm wavelength range. GECO features noncollinearity angle adjustment and can be simply transformed to a collinear setup, allowing the performance of interferometric autocorrelation measurements which are useful for pulses in the 10 fs range. Both arms of the autocorrelator have the same dispersion parameters for the most accurate results. GECO comes with a convenient pulse-analysis software, providing straightforward pulse duration measurements. A computer is integrated inside the autocorrelator thus communications are handled via TCP/IP protocol which ensures a simple trouble-free installation. Software and hardware are also capable of generating FROG traces, provided that an external spectrometer is connected to the fiber coupler. Software APIs are available for custom user adaptations.



SPECIFICATIONS

Input wavelength range	500 – 2000 nm	
Temporal resolution	0.13 fs / step	
Measurable pulse width	10 – 20000 fs	
Minimum average power of radiation	Outputs from amplifiers	2 – 200 mW @ 1 – 1000 kHz
	Outputs from oscillators	>400 mW @ 75 MHz, 800 nm, ~100 fs >250 mW @ 75 MHz, 1030 nm, ~100 fs
Scan rate	5 scans/second @ 1 – 1000 kHz	
Detector	Si photodiode	

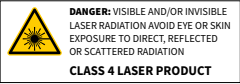

OUTLINE DRAWINGS

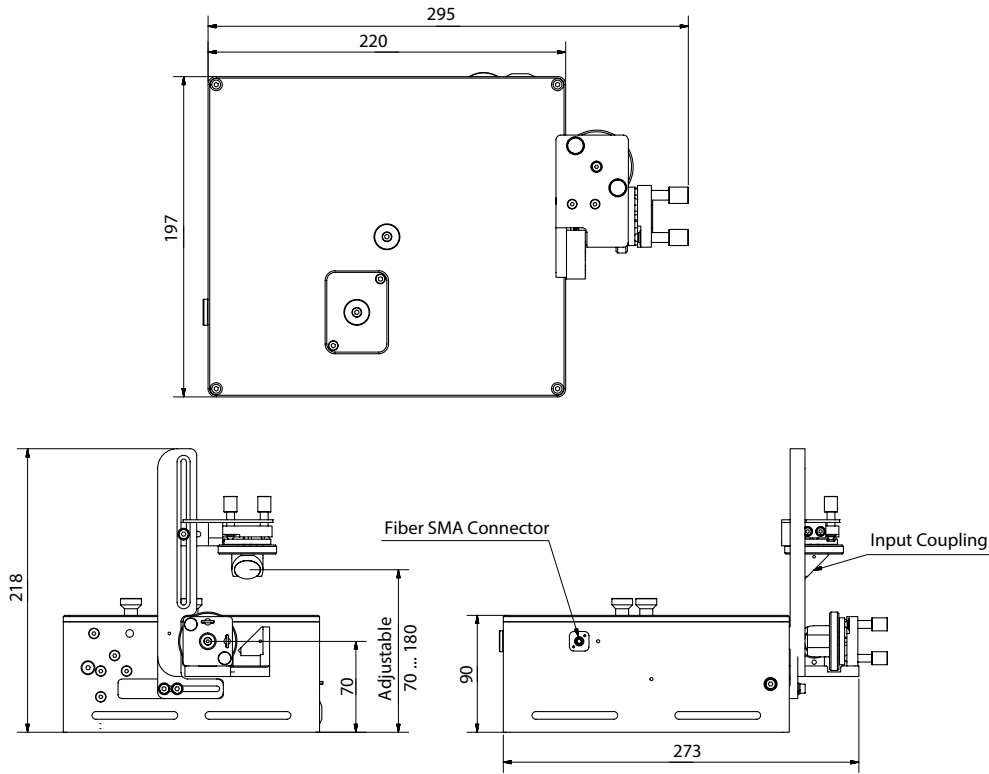

GECO outline drawings

TIPA

Single-Shot Autocorrelator for Pulse-Front Tilt and Pulse Duration Measurements

FEATURES

- 30 fs – 1 ps pulse duration range
- 500 – 2000 nm wavelength range
- Measures pulse-front tilt
- Compact and portable design
- Hi-speed 12-bit CCD camera
- Pulse-analysis software for pulse duration measurements

TIPA is an invaluable tool for alignment of ultrashort pulse laser systems based on the chirped pulse amplification technique. Its unique design allows monitoring and measuring of the pulse duration as well as the pulse front tilt in both vertical and horizontal planes. TIPA is a straightforward and accurate direct pulse-front tilt measurement tool. Operation of TIPA is based on non-collinear second harmonic (SH) generation, where the spatial distribution of the SH beam contains information on the temporal shape of the fundamental pulse. This technique combines low background and single-shot measurement capability. The basic idea is that two replicas of a fundamental ultrashort pulse pass non-collinearly through a nonlinear crystal, in which SH generation



takes place. SH beam's width and tilt in a plane perpendicular to propagation provide information about the pulse duration and pulse front tilt. The SH beam is sampled by the included CCD camera. TIPA comes with a user-friendly software package, which provides on-line monitoring of incoming pulse properties.

PERFORMANCE SPECIFICATION

Wavelength range	500 – 530 nm	530 – 700 nm	700 – 2000 nm
Temporal resolution	~500 fs/mm		
Measurable pulse width	40 – 120 fs	40 – 1000 fs	30 – 1000 fs
Minimum pulse energy	single-shot mode: ~30 – 100 μ J @ 1 – 10000 Hz integration mode: ~1 – 5 nJ @ 1 – 1000 kHz		
Detector	CCD		

CCD SPECIFICATIONS

Maximum resolution	1296 (H) \times 964 (V)
Pixel size	3.75 μ m \times 3.75 μ m
Analog-to-Digital converter	12 bits
Spectral response ¹⁾	0.35 – 1.06 μ m
Power consumption from USB bus	2 W (max) at 5 V

¹⁾ With glass window.

TIPA MODELS ¹⁾

Model	Operation wavelength
AT1C1	700 – 900 nm
AT2C1	900 – 1100 nm
AT5C3	500 – 2000 nm

¹⁾ Non-standard models available on request.

DIMENSIONS

General dimensions of the housing	123 (W) \times 155 (L) \times 68 (H) mm
Recommended area for fixing	212 (W) \times 256 (L) mm
Beam interception height	100 – 180 mm

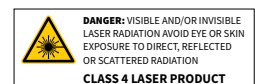

OUTLINE DRAWINGS

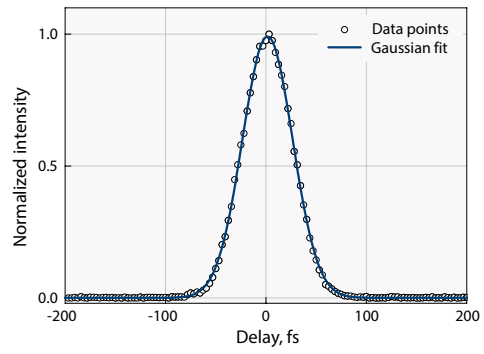
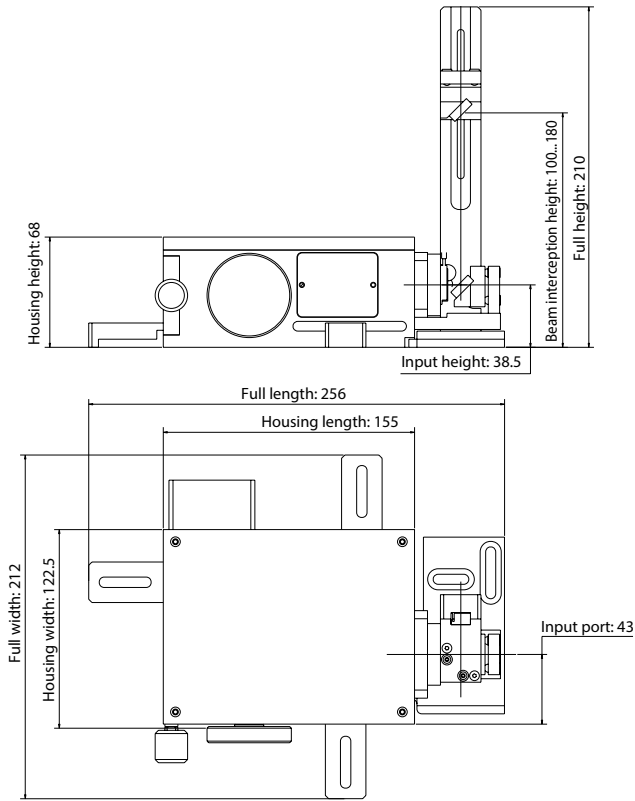

Sample autocorrelation with data fitting.
TOPAS Idler Autocorrelation at 1700 nm
(40 fs pump)

MEASUREMENT INFO

Gaussian Width:	18.8 px – 58.8 fs
FWHM Width:	19.2 px – 59.8 fs
Gaussian Pulse Duration:	41.6 fs
Sech ² Pulse Duration:	38.2 fs
Pulse Tilt:	-0.210 deg

View of the TiPA software window

CCD control and info panels on the left; image captured by CCD – middle; processed time profile of the image with Gaussian fit, and processed space profile of the image – right top and bottom respectively.

List of Local Distributors

AUSTRALIA	Lastek Pty Ltd Thebarton, Australia Tel: +61 8 84 438 668 alex.stanco@lastek.com.au www.lastek.com.au	ITALY	Optoprim S.r.l. Monza, Italy Phone: +39 039 834 977 info@optoprim.it www.optoprim.it
BENELUX COUNTRIES	Laser 2000 Vinkeveen, Netherlands Tel: +32 11 75 79 87 dloos@laser2000.nl www.laser2000.nl	JAPAN	Phototechnica Corp. Saitama, Japan Phone: +81 48 871 0067 kkakuta@phototechnica.co.jp www.phototechnica.co.jp
BRAZIL	Photonics São Paulo, Brazil Phone: +55 11 2839-3209 info@photonics.com.br www.photonics.com.br	POLAND	Amecam Warszawa, Poland Phone: +48 22 207 2278 amecam@amecam.pl www.amecam.pl
CZECH REPUBLIC & SLOVAKIA	Femtonika s.r.o. Zbýšov, Czech Republic Phone: +420 792 417 400 jan.hubert@femtonika.cz www.femtonika.cz	RUSSIA	ООО “Промэнерголаб” Moscow, Russia Phone: +7 495 22 11 208 info@czl.ru www.czl.ru
CHINA	Brilliant Instruments Technology Co. Ltd. Beijing, China Tel: +86 10 5126 2828 lij@mlvz.com www.mlvz.com	SINGAPORE	Acexon Technologies Pte Ltd Singapore Tel: +65 6565 7300 sales@acexon.com www.acexon.com
CHINA	Genuine Optronics Limited Shanghai, China Tel: +86 21 64 325 169 jye@gen-opt.com www.gen-opt.com	SPAIN & PORTUGAL	INNOVA Scientific S.L. Las Rozas de Madrid, Spain Tel.: +34 91 710 56 50 rafael.pereira@innovasci.com www.innovasci.com
FRANCE	Optoprim SAS Paris Paris, France Phone: +33 1 41 90 33 77 fbeck@optoprim.com www.optoprim.com	SWITZERLAND	Dyneos AG Effretikon, Switzerland Tel: +052 355 12 40 info@dyneos.ch www.dyneos.ch
FRANCE & SWITZERLAND	Marc Watremez Industrial Market Development Manager Phone: +33 609 16 9538 marc.w@lightcon.com	TAIWAN	Alaser Taipei, Taiwan Tel: +886 2 2377 3118 alexfu@alaser.com.tw www.alaser.com.tw
GERMANY	TOPAG Lasertechnik GmbH Darmstadt, Germany Phone: +49 6151 4259 78 info@topag.de www.topag.de	UNITED KINGDOM	Photonic Solutions Edinburgh, UK Phone: +44 0 131 664 8122 ben.agate@photonicsolutions.co.uk www.photonicsolutions.co.uk
GERMANY, AUSTRIA & SWITZERLAND	Ulrich Hoechner Industrial Market Development Manager Phone: +49 157 8202 5058 U.Hoechner@lightcon.com		
INDIA	ANATECH Laser Instruments Pvt. Ltd. Mumbai, India Tel: +91 22 4121 0001 / 02 sales@anatechlaser.com www.anatechlaser.com		
ISRAEL	IL Photonics BSD Ltd. Beit Shemesh, Israel Tel: +972 2 992 1480 moshe@ILPhotonics.com www.ILPhotonics.com		

Lost in calculations?

TRY INTERACTIVE CALCULATORS FOR SCIENTISTS & ENGINEERS

toolbox.lightcon.com



LIGHT CONVERSION CHINA

702-1, F1 Building, TCL Science Park, No.1001
Zhongshanyuan Road, Nanshan Dist., Shenzhen, China
Phone: +86 138 2376 0064
yiliping@cn.lightcon.com

LIGHT CONVERSION KOREA

520-ho, 65, Techno 3-ro,
Yuseong-gu, Daejeon, 34016, Korea
Phone: +82 42 368 1010
jungsik.seo@lightcon.com

LIGHT CONVERSION USA

201 South Wallace Ave., Suite B-2C
Bozeman, MT 59715, USA
Phone: +1 866 658 5404
Fax: +1 866 658 7357
SalesLC@LightCon-USA.com



LIGHT CONVERSION

Keramiku 2B, LT-10233 Vilnius, Lithuania

Tel.: +370 5 2491830
Website: www.lightcon.com
Sales: sales@lightcon.com
OPA support: support@lightcon.com
Lasers support: lasers@lightcon.com